

# SANS at MLZ



## Newsletter

15

MLZ is a cooperation between:



**Helmholtz-Zentrum  
Geesthacht**  
Zentrum für Material- und Küstenforschung



Technische Universität München

### The Heinz Maier-Leibnitz Zentrum (MLZ):

The Heinz Maier-Leibnitz Zentrum is a leading centre for cutting-edge research with neutrons and positrons. Operating as a user facility, the MLZ offers a unique suite of high-performance neutron scattering instruments. This cooperation involves the Technische Universität München, the Forschungszentrum Jülich and the Helmholtz-Zentrum Geesthacht. The MLZ is funded by the German Federal Ministry of Education and Research, together with the Bavarian State Ministry of Education, Science and the Arts and the partners of the cooperation.

Bavarian State Ministry of  
Education, Science and the Arts



SPONSORED BY THE



Federal Ministry  
of Education  
and Research



# The Importance of Neutrons in Research Activities

An editorial by

The ecosystem of world leading neutron facilities, national and international, and small, medium or large in size, is changing substantially in Europe in the upcoming years. Scientists from all over Europe are currently preparing themselves to exploit the most intense neutron source in the world, the European Spallation Source ESS, that started construction in Lund, Sweden last year. However, the access of researchers to neutron beam time is seriously threatened by an imminent reduction of 25 to 50% in capacity in the provision of neutrons in Europe in the next 15 years. In this context of the impending threats and opportunities the **European Neutron Scattering Association ENSA** has highlighted the power of neutrons in a brochure available online or in print on request. It shows some current typical examples from the academic and industrial user communities that have been chosen to illustrate the scope and potential of neutron research to address the grand challenges of our today's society.

A high level of integration between the neutron facilities and the user community has been achieved through a series of European-funded projects, supporting dissemination, training and outreach, and most important to provide the open access to nationally funded neutron sources. It enables beam time use for scientists outside their home nations, favours scientific exchanges in the spirit of European ideas and it is of particular benefit for the majority of countries without own infrastructure for neutron supply. An open access modus operandi of the facilities organised in the NMI3 consortium ([nmi3.eu](http://nmi3.eu)) has thus emerged for all European scientists. The actual programme will end in January 2016, but thanks to strong convincing actions of the community, a possible continuation programme is included in the actual call from the EU and hopefully could start in 2017.



*Christiane Alba-Simionesco*

*Directeur du Laboratoire Léon Brillouin*

*Chair of the European  
Neutron Scattering Association*

## Read more

in the new ENSA-brochure  
*Neutrons for science and technology:*  
[neutrons-ensa.eu](http://neutrons-ensa.eu)



or scan the qr-code  
for download

## Let's talk about Small Angle Neutron Scattering at MLZ!

In this article we introduce the newly developed set-ups and instrumental options which have recently been implemented in the nano- and microscale instrument suite of MLZ. Illustrated by recent examples, we particularly present techniques like stroboscopic **small angle neutron scattering (SANS)** and **time resolved small angle neutron experiments (TISANE)** for kinetic experiments, high resolution structure analysis, polarisation analysis using  $^3\text{He}$ , and **neutron Grating Interferometry (nGI)**.

As a recent highlight in this context, researchers at MLZ and PSI combined the standard SANS and very **small angle neutron scattering (VSANS)** technique with the newly developed nGI set-up for a textbook study of universal domain structures in the type-II superconducting model system Niobium [1]. Such universal structures with striking similarities can be found in a wide range of different physical, chemical or biological systems. Although the physics hidden behind such domain patterns may be completely different, a competition of interactions featuring uniform phase distribution versus phase separation is the common link. In consequence, these systems exhibit similar domain morphologies including the well-known generic stripe, bubble or dendritic patterns, seen on a wide range of length scales, mostly in the nanoscale and  $\mu\text{m}$  range. In superconductors, domain morphology and size can easily be tuned by a simple variation of magnetic field and temperature which makes them an ideal model system to study such general physical behaviour. The unique combination of three different neutron techniques allowed covering a large range of spatial correlations from  $20 \text{ \AA}$  to several  $\mu\text{m}$ . Moreover, the new imaging technique nGI even allows spatially resolved measurements in real space of reciprocal space scattering signatures of  $\mu\text{m}$  domains. Typical data are shown in fig. 1.

SANS is a powerful technique to study correlations of various samples in the range of 20 to 2000  $\text{\AA}$ . Typical applications include measurements of precipitates, segregation and voids in metallurgical samples [2], complex biological samples of polymers, proteins and functional macromolecules or membranes [3]. In magnetism, non-trivial large scale magnetic structures like magnetic spirals [4], Skyrmion lattices [5], superconducting vortex lattices [6], and micromagnetic systems

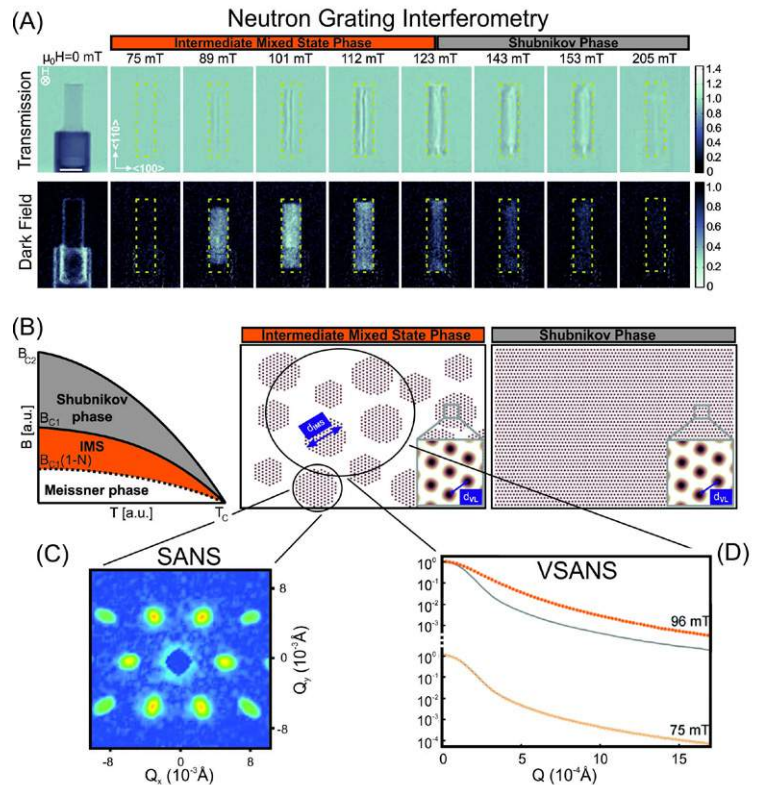

Fig. 1: (A) Transmission and dark field image of a superconducting niobium sample obtained by the nGI technique [1]. (B) Phase diagram of superconducting niobium with the schematic visualization of the corresponding morphology of the superconducting vortex lattice and its domain superstructure. (C) SANS and (D) VSANS scattering pattern showing the morphology of the vortex lattice and the domain structure, respectively.

[7] are typically addressed by means of SANS. Larger length scales – typically up to several  $\mu\text{m}$  – can be addressed by means of VSANS and **ultra small angle neutron scattering (USANS)** instruments. Two main instrumental concepts can be distinguished: Double crystal diffractometers (Bonse Hart camera), using the double reflection at ultra-perfect single crystal silicon monochromators for unique resolution, and focussing SANS instruments, where an elliptical mirror is used to extend the angular resolution of a standard pinhole SANS. Finally, nGI is based on the installation of a set of diffraction gratings at a neutron imaging beamline. With the help of two  $\mu\text{m}$  pitch gratings, scattering signatures of  $\mu\text{m}$  domains become visible with real space resolution. The real space technique nGI offers a completely different route to investigations of nano- and microstructured samples, ideally complementing the reciprocal space resolution of SANS and VSANS instruments.

Let's have a look at all those instruments dedicated for micro- and nanostructured samples at MLZ. We particularly intend to highlight the diversity of the instruments and their unique features – going beyond the standard SANS approach.

## KWS-1

High resolution multipurpose SANS instrument

The instrument KWS-1 [8] is optimised for mainly two purposes: polarisation and polarisation analysis experiments and grazing incidence experiments (GISANS). The first option aims at magnetic structures that must be distinguished from the nuclear structure (fig. 2). The magnetic domain orientation is to be resolved to a high level. The grazing incidence option aims at thin film structures that by using evanescent neutron wave fields lead to a well-separated depth information about the structure. In this way, surface effects can be

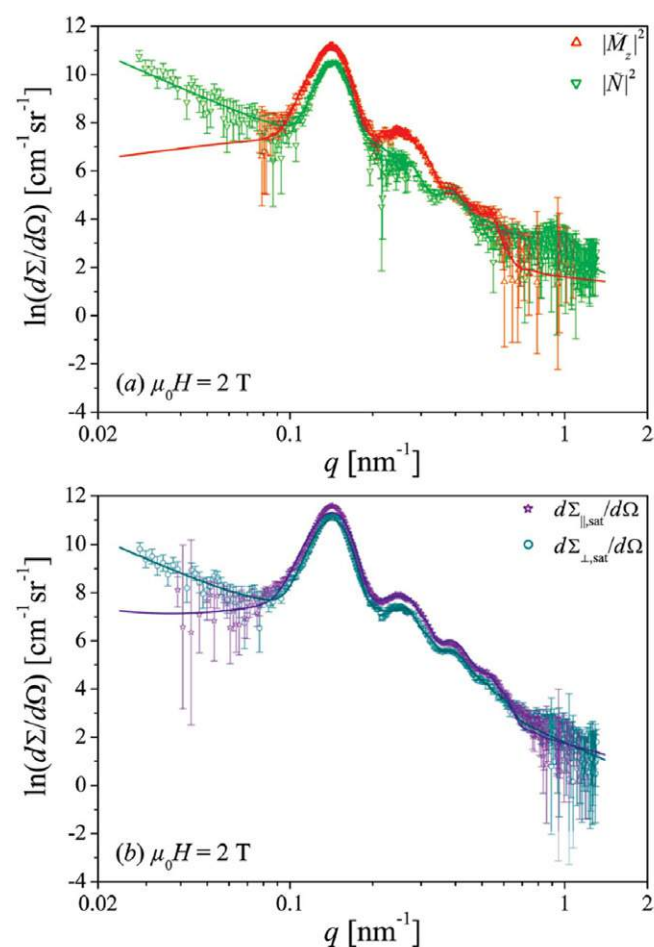

Fig. 2: Separation of nuclear and magnetic scattering from Co nano rods arranged in arrays [9]. The soon upgrade of KWS-1 to  $^3\text{He}$  polarisation analysis will allow even more detailed analyses.

studied quite conveniently. The combination of these two methods aims at thin film magnetic domain structures and points towards future applications of data storage and spintronic devices.

In either method a standard resolution of  $\Delta\lambda/\lambda = 10\%$  is desired in order to well separate mesoscopic Bragg peaks and well defined critical angles of total reflection. An additional chopper was installed to extend the wavelength resolution down to ca. 1% by combining the beam chopping with time-of-flight analysis. One example measurement is given below for KWS-2.

The polariser and spin-flipper had been commissioned successfully [8]. We obtained a polarisation of better than 93%. Additionally, new SEOP  $^3\text{He}$  cells are developed currently for different scattering angles. Special for KWS-1 will be the focus on small scattering angles for large structures that require extremely clean windows for the SEOP cell. For the sample magnetisation we provide a classical yoke magnet (ca. 1.5 T) and a compensated cryomagnet (5 T) [9].

For GISANS experiments a specially developed hexapod serves for highest precision in sample positioning (0.01 mm/ 0.01°) of heavy loads, such as the already introduced magnets. All collimation and sample apertures are rectangular that allow for slit geometry. Thus, the desired incident angle is usually defined to a high degree, which is needed for measurements close to the critical angle of total reflection.

Neutron lenses serve for higher intensities and/ or higher resolution by focussing the beam on the detector. Further details are discussed below for KWS-2.

## SANS-1

Fast kinetics for materials & magnetism

Recently commissioned as a joint project of TUM and HZG, SANS-1 is a 40 m pinhole instrument dedicated to the investigations of materials and magnetism. Its performance had been proven by first successful experiments in both magnetism [1, 10, 11] and materials science [2, 12].

In its standard SANS configuration, two velocity selectors ( $\Delta\lambda/\lambda = 10\%$  and 6%) for medium/ high resolution



Fig. 3: Installation of the TISANE chopper disk at SANS-1 (Nov. 2015).

feed the 20 m collimation system. Due to the flexible layout of the collimator, free space is still available for future upgrades such as focussing lenses, a spin echo option, a multi-beam SANS or a GISANS option. Dedicated to magnetism,

a set of two Fe/Si transmission polarisers ( $P < 95\%$ ) cover a broad wavelength band from 4.5 to 16 Å and are completed by a RF spin-flipper.

Responding to the rising demand for diffraction in SANS geometry – in particular for condensed matter physics – a heavy duty goniometer works as foundation for different sample environments. It is designed to precisely position heavy equipment like the 5 T SANS magnet, various cryostats, furnaces or a tensile rig. The spacious sample area is built using non-magnetic materials wherever possible.

The large accessible Q-range of SANS-1 ( $0.0002 \text{ \AA}^{-1} < Q < 1 \text{ \AA}^{-1}$ ) is facilitated by the sideways movement of the 1 m<sup>2</sup> detector inside the 22 m detector tube. The detector is made up of 128 position sensitive <sup>3</sup>He tubes and provides 8 mm x 8 mm pixel resolution with 10% deadtime at 2.5 MHz. A second, small detector (active area of 0.5 x 0.5 m<sup>2</sup>) with higher resolution of 3 mm x 3 mm will be installed downstream of the first detector, allowing a better dynamic range and providing the necessary resolution for a conventional VSANS setup.

A further feature of SANS-1 is a dedicated TISANE double-disk chopper, which allows for fast kinetic measurements down to  $\mu\text{s}$  time-scales [13]. With 14 equal windows (9° opening angle) and a maximal speed of 20.000 rpm, the TISANE disks can be operated both co- and counter-rotating delivering a flex-

ible pulse shape (fig. 3). In a kinetic experiment the sample is oscillated with an arbitrary external control parameter, e.g. an AC field in the case of magnetic samples. The response of the sample to this cyclic process is measured with  $\mu\text{s}$  time resolution.

## KWS-2

Highest flux for soft matter samples

The strategy of KWS-2 [14] is to compromise with the resolution of  $\Delta\lambda/\lambda = 20\%$  to obtain the highest fluxes in SANS to observe time-critical kinetics [15] or smallest amounts in intensity-critical contrast variation experiments [16]. Very often this demand points towards soft matter research. The frequently used stopped-flow cells allow for studying fast kinetics in the sub-second range [15]. The latest development of an ultra fast <sup>3</sup>He gas tube detector allows for count rates of 8 MHz (10% dead time at 4 MHz).

The highest intensities are supported by neutron lenses [17] that focus on the detector and that allow for larger samples. By this, further intensity gains of up to 30 are realised. Apart from raising the intensity, the resolution can be increased further down to Q-values of ca.  $10^{-4} \text{ \AA}^{-1}$  [17] in concert with the high resolution detector. The general resolution can be increased for all ranges of Q by using the chopper that combines beam chopping with time-of-flight measurements [18]. A typical resolution of  $\Delta\lambda/\lambda = 2\%$  was reached at similar intensity levels of an optimised velocity selector (fig. 4).

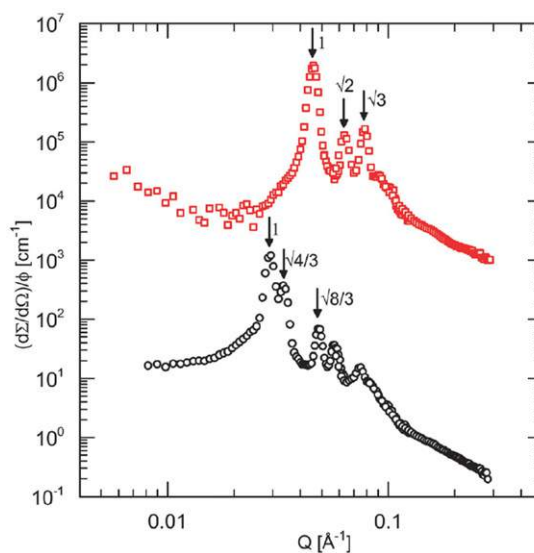

Fig. 4: SANS image of liquid crystalline order of micelles at high concentrations using enhanced resolution [18]. By using choppers the resolution was increased to  $\Delta\lambda/\lambda = 2\%$ .

In contrast to KWS-1, the built-in polarisation and polarisation analysis ( $^3\text{He}$ ) option aims at larger angles. Apart from studying smaller structures in the 1 - 5 nm range, the incoherent background can be determined and subtracted exactly. That is, for instance, highly desired for biological samples where the interesting protein structure information is buried by the incoherent background. Up to two orders of lower intensities can be distinguished

### KWS-3

Elliptic mirror VSANS

The focussing mirror SANS instrument KWS-3 is optimised for the intermediate Q-range between the pinhole SANS (down to ca.  $10^{-3} \text{ \AA}^{-1}$ ) and the double crystal (Bonse Hart) camera (up to ca.  $5 \times 10^{-5} \text{ \AA}^{-1}$ ). The non-dispersive neutron mirror focuses the entrance aperture of typically  $1 \times 1$  or  $2 \times 2 \text{ mm}^2$  on the detector over the full wavelength band of the selector  $\Delta\lambda/\lambda = 10\%$ . Highest possible intensities are obtained even with samples smaller as the maximal size of  $10 \times 2 \text{ cm}^2$ . Often sample volumes of 0.6 ml are sufficient for measurements within one to four hours. An example for a large enhanced Q-range is shown in fig. 5.

Additional instrument options aim at better resolution by using a smaller entrance aperture, or at higher Q in the range of  $0.1 \text{ \AA}^{-1}$  for fast cross-checks with the conventional SANS [19].

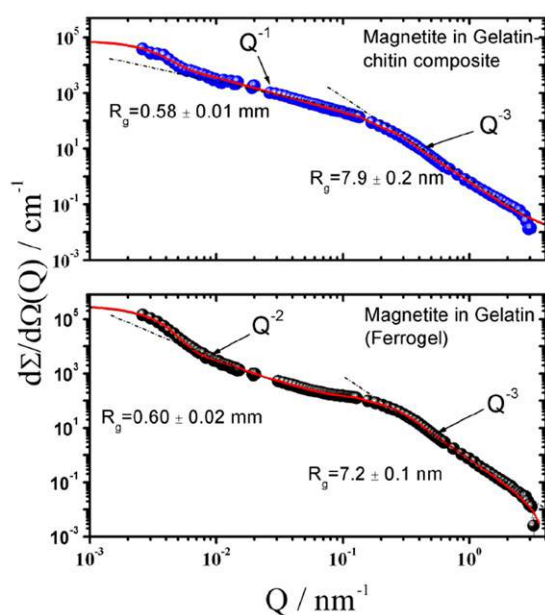

Fig. 5: Hierarchical structures of nacre and tooth mimicking nanocomposites with combined measurements over length scales from nm (classical SANS) to  $\mu\text{m}$  (KWS-3). Example taken from [19].

### nGI @ ANTARES

Real space mapping of USANS scattering

Going beyond SANS by adding spatial resolution to SANS – or going beyond imaging by adding Q-resolution to imaging. The newly installed technique nGI can be seen under these two perspectives. With the help of a set of absorption and neutron phase gratings at the imaging beamline ANTARES, nGI visualises scattering of  $\mu\text{m}$  sized structures in real space (fig.6).

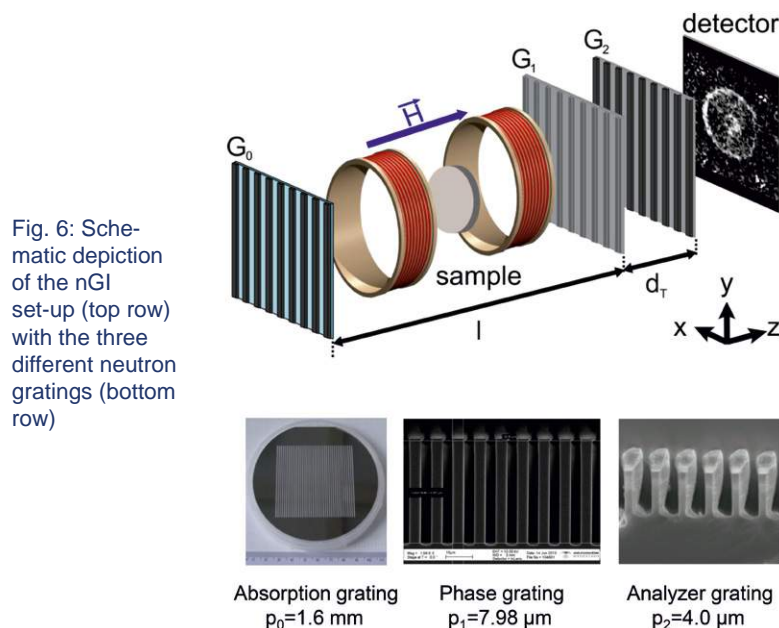

Fig. 6: Schematic depiction of the nGI set-up (top row) with the three different neutron gratings (bottom row)

As given by the pitch of the gratings, the Q-sensitivity of nGI lies in the USANS range with 2 - 20  $\mu\text{m}$ . Whereas the real space resolution is given by the imaging detector (typically down to 0.1 mm) and strongly depends on the sample - detector distance. However, nGI is only sensitive to scattering components perpendicular to the lines of the gratings. A weakness which is overcome by a unique feature of the ANTARES nGI setup, which is capable of rotating all three gratings simultaneously around the beam axis. With such directional imaging it becomes possible to locally quantify anisotropies in the scattering structure and to determine the direction of  $\mu\text{m}$  textures.

nGI is a major step to bridge the gap between scattering and imaging techniques and clearly broadens the application range of ANTARES, in particular when used in combination with standard SANS and VSANS instruments.

Possible applications span a wide range from the observation of domain nucleation in magnetic [20] or superconducting systems [1] to material testing for small pores or the investigation of corrosion processes.

## RefSANS

Horizontal TOF reflectometer with GISANS Option

Nanostructures in thin films are the application area of RefSANS. The sample can be kept horizontal, allowing not only measurements of films on a solid substrate but also at the liquid - air interface. The structure of these films can be probed both in the out-of-plane direction by using the instrument in its reflectometry configuration and in the in-plane direction by switching to the GISANS mode. This switch can be done easily, leaving the sample in place so that externally applied fields or constraints (e.g. temperature or chemical environment) will be the same in both measurements.

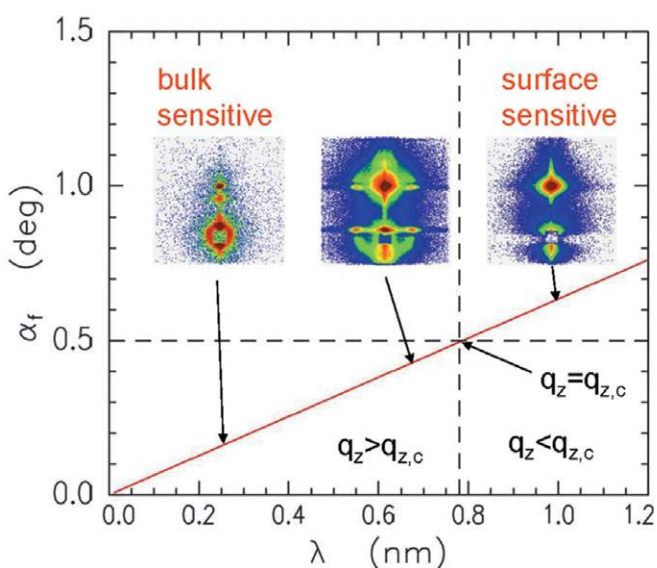

Fig. 6: How TOF-GISANS makes it possible to extract depth resolved structural information. With increasing wavelength the surface sensitivity is enhanced and different morphologies present in a block copolymer thin film are revealed [21].

The instrument uses a polychromatic incident neutron beam and time-of-flight (TOF) wavelength determination. The beam can be up to 80 mm wide and can be point focussed onto the detector in 9 m distance for GISANS measurements. Since the wavelength and the angle of the incident neutron beam determine the momentum transfer, typical specular reflectometry curves are recorded using only three incident angles to cover a  $Q_z$  range of 0 - 3 nm<sup>-1</sup>. In the case of

GISANS, the TOF mode makes it possible to probe different depths in the sample using a single incident angle (fig. 6). The wavelength resolution can be tuned between 1 and 10% which makes it possible to find the optimal flux/ resolution ratio for each sample and the incident neutron beam can additionally be polarised for studies of magnetic nanostructures.

RefSANS uses the so-called event list mode which means that every recorded neutron is tagged with its absolute detection time. This allows sophisticated a posteriori analyses of the data since different histogramming schemes can be applied in order to extract the best out of the measured data. In particular, this method makes it possible to sort the neutrons according to their timing with respect to external events or control parameters (temperature, electric, magnetic field, pressure...) which can be varied during the experiment. If the physical problem under investigation is periodic, it is possible to use this technique to perform stroboscopic measurements where the accumulation of many frames and optimal binning can lead to a time resolution down to the millisecond range.

*S. Mühlbauer (FRM II),  
H. Frielinghaus (JCNS),  
M. Schulz (TUM),  
J.-F. Moulin (HZG)*

## Read more:

- [1] T. Reimann et al., *Nature Communications* 6, 8813 (2015)
- [2] R. Gilles et al., *Journal of Alloys and Compounds*, 612, p. 90-97 (2014)
- [3] P. Mueller-Buschbaum et al., *Colloid and Polymer Science* 277 12, p. 1193-1199 (1999)
- [4] S.-A. Siegfried, *Phys. Rev. B* 91, 184406 (2015)
- [5] S. Mühlbauer et al., *Science* 323, 5916, p. 915-919 (2009)
- [6] M. Laver et al., *Phys. Rev. B*, 79, 014518 (2009)
- [7] A. Michels, *Journal of Physics: Condensed Matter* 26, 38, p. 383201 (2014)
- [8] A.V. Feoktystov et al., *J. Appl. Cryst.* 48, 1, p. 61-70 (2015)
- [9] A. Günther et al., *J. Appl. Cryst.* 47, p. 992-998 (2014)
- [10] P. Milde, et al., *Science* 340, 6136, p. 1076-1080 (2013)
- [11] S. V. Grigoriev, et al., *Phys. Rev. B* 90, p. 174414 (2014)
- [12] S. Seidlmayer et al., *Journal of the Electrochemical Society* 162, 2, 3116-3125 (2015)
- [13] A. Wiedenmann et al., *Phys. Rev. Lett.* 97, 5, 057202 (2006)
- [14] A. Radulescu et al., *Journal of Physics: Conference Series* 351, 1, p. 012026 (2012)
- [15] T. Zinn et al., *Soft Matter* 8, p. 623-626 (2012)
- [16] H. Endo, et al., *Journal of Chemical Physics* 115, p. 580-600 (2001)
- [17] H. Frielinghaus et al., *J. Appl. Cryst.* 42, p. 681-690 (2009)
- [18] M. Amann et al., *Soft Matter* 11, p. 4208-4217 (2015)
- [19] M. Sigleitmeier et al., *Beilstein J. Nanotechnol.* 6, p. 134-148 (2015)
- [20] I. Manke et al., *Nat. Commun.* 1, 125 (2010)
- [21] P. Mueller-Buschbaum et al., *J. Appl. Cryst.* 47, p. 1228-1237 (2014).



## KWS-2: A new multi-MHz detection system

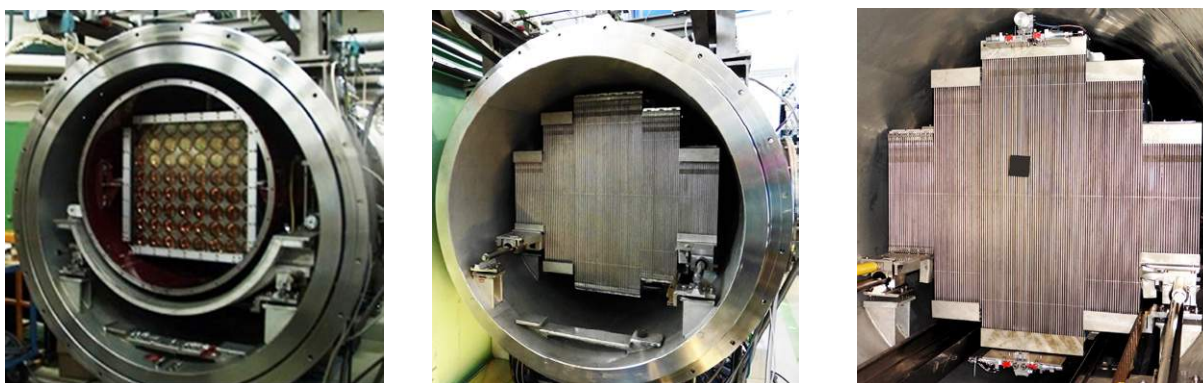

From left to right: The old detector, then during the installation phase, and finally the new one with the mobile (XY) beam stop visible.

The small-angle neutron diffractometer KWS-2, operated by JCNS at MLZ, is dedicated to the investigation of mesoscopic multi-scale structures and structural changes due to rapid kinetic processes in soft condensed matter and biophysical systems. Following demands from the user community, it was recently considerably upgraded, aiming for boosting its performance with respect to the intensity on the sample, the instrumental resolution, and the minimum scattering variable  $Q_{\min}$ . In the high-intensity mode, up to twelve times intensity gain compared to the conventional pin-hole mode for the same resolution can be achieved with lenses based on increasing of the sample size. In the tunable resolution mode, with chopper and TOF data acquisition, improved characterisation of the scattering features within different  $Q$  ranges is enabled by the possibility to vary the wavelength spread  $\Delta\lambda/\lambda$  between 2 and 20%. In the extended  $Q$ -range mode by means of lenses and a secondary high-resolution detector (pixel size of 0.45 mm) a  $Q_{\min}$  down to  $1 \times 10^{-4} \text{ \AA}^{-1}$  can be achieved, which in combination with the pinhole mode, permits the exploration of a continuous length scale from 1 nm to 1 micron.

A vast performance improvement was achieved by the recent upgrade of the instrument's detection system. A new detector consisting of an array of  $^3\text{He}$  tubes with an active detection area equivalent to  $0.9 \text{ m}^2$  and innovative rapid readout electronics replaced the old (scintillation, 60 cm x 60 cm) system. The detector's masterpiece was supplied by GE Reuter Stokes Inc. and installed in close collaboration with the JCNS and ZEA-2 (Central Institute for Engineering, Electronics and Analytics – Electronic Systems) teams on-site. To improve the

read-out characteristics and reduce the noise, the detection electronics is mounted in a closed case on the backside of the  $^3\text{He}$  tubes frame. The tubes' efficiency is about 85% (for  $\lambda = 5 \text{ \AA}$ ) and the resolution slightly better than 8 mm.

The new detection system is characterised by a dead time constant of 25 ns and a count rate as high as 5 MHz at 10% dead time. Compared to the old detector this is an improvement of factor 25. The much higher count rate will shorten the measurement times and thus, increase the number of experiments in the same time period by the optimal use of the high flux of up to  $2 \times 10^8 \text{ n cm}^{-2} \text{ s}^{-1}$  at the sample position.

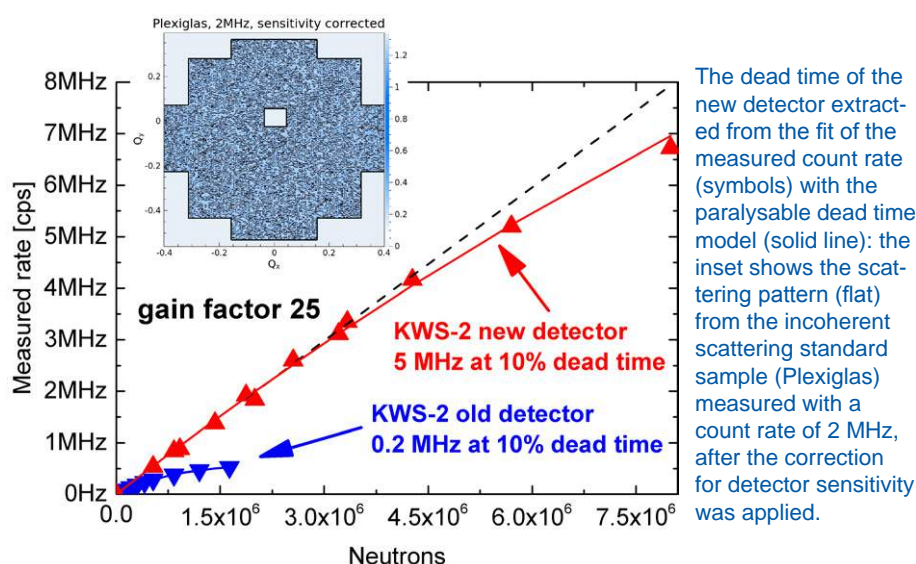

The dead time of the new detector extracted from the fit of the measured count rate (symbols) with the paralyzable dead time model (solid line): the inset shows the scattering pattern (flat) from the incoherent scattering standard sample (Plexiglas) measured with a count rate of 2 MHz, after the correction for detector sensitivity was applied.

In addition this will enable new scientific opportunities in the field of structural investigations of small soft matter and biological systems. These systems typically deliver at high wave-vector transfers  $Q$  only a very weak scattering signal above the buffer or solvent level, which now can be resolved due to the performance jump enabled by the new detector.

*A. Radulescu, N.K. Szekely, M.-S. Appavou (JCNS)*

## A quicker turn at SPHERES: Upgrade of the phase space transform chopper

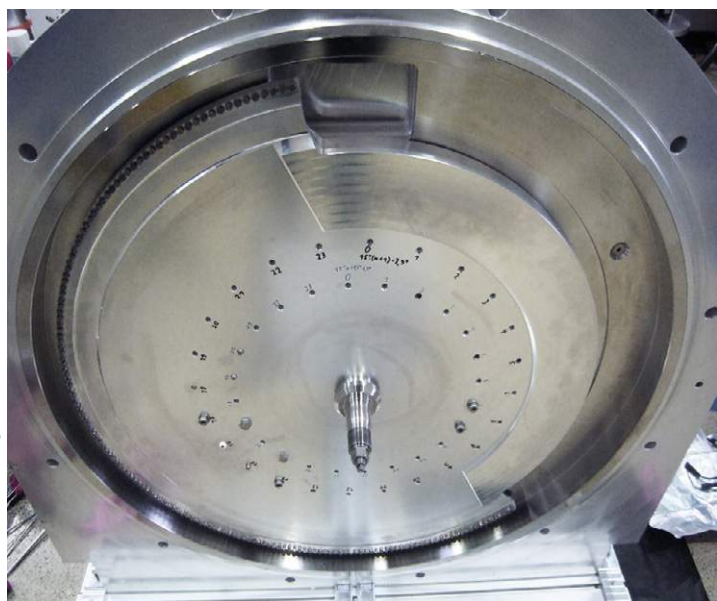

Left: The new one-wing chopper disk (215° reflecting, 145° open). The radius of 43 cm is calculated for the designed speed of 225 m/s at a rotation frequency of 83 Hz.

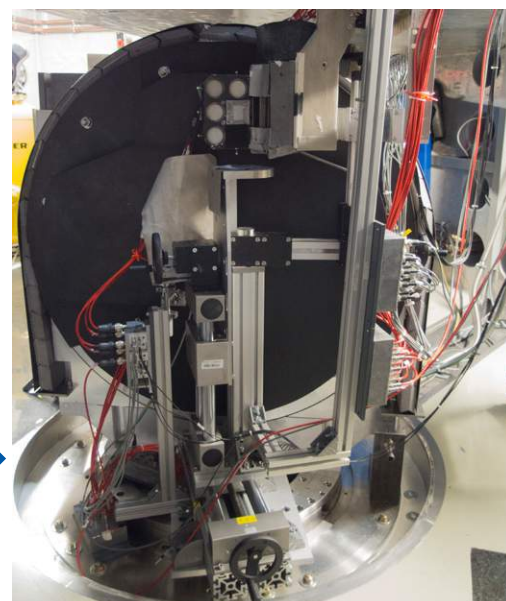

Right: The new chopper enclosed in its shielding installed inside SPHERES.

SPHERES (**SP**ectrometer for **H**igh **E**nergy **RES**olution) is a third-generation neutron backscattering spectrometer employing focussing optics and a **phase space transform (PST) chopper**. The chopper has a threefold function: it not only acts as a duty-cycle chopper and primary beam deflector, but by the motion of the mosaic graphite crystals on its circumference a phase space transformation of the incoming wavelength spectrum is achieved, which enhances the usable flux at the monochromator.

Mechanical restrictions limited the optimal use of the original three-wing PST chopper. It could only be operated with 1/3 of the originally intended crystal speed

of 300 m/s at 79 Hz. New insights from simulations give now an optimal speed for the phase space transformation around 250 m/s. Therefore a new more compact PST chopper had been designed.

In order to use a larger fraction of the duty cycle, a one-hole chopper is preferred to the original three-hole geometry. The new design of an one-wing chopper is mechanically quite challenging. This innovative work was carried out by the Central Institute for Engineering, Electronics and Analytics (ZEA-1) of Forschungszentrum Jülich. In addition to the chopper's upgrade, the graphite deflector crystals had also been replaced with ones of a higher reflectivity and mosaicity to further increase intensity.

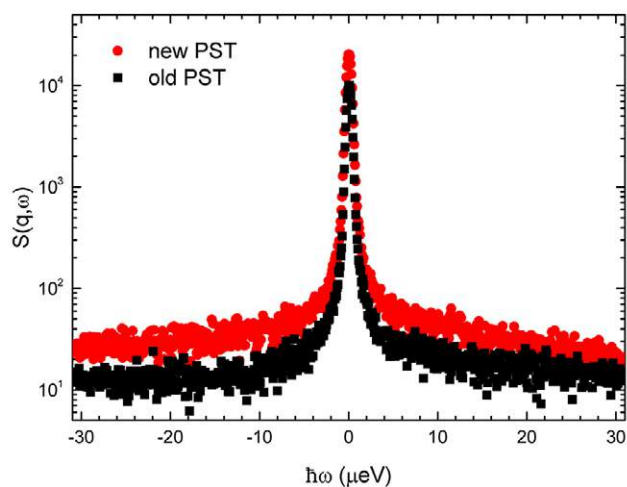

Comparison of the measured resolution function with old (black symbols) and new (red symbols) PST chopper integrated over nine large angle detectors.

This summer the new PST chopper was installed at the instrument and successfully taken into operation in the last reactor cycle. It runs now with the desired frequency at a speed of 225 m/s close to the optimum for the phase space transformation. The graph on the left shows clearly that the increased velocity and the better deflector crystals double the intensity in most detectors. Beside the intensity increase of a factor 2, the signal-to-noise ratio for the large angle detectors was improved by about 10%. A couple of low intensity scattering experiments already benefited from the enhanced performance of SPHERES.

*M. Zamponi, M. Khanef, J. Wuttke (JCNS)*

## Hottie at SPHERES: New high temperature furnace



The high temperature furnaces (HTFs) used at MLZ were designed for experiments at temperatures up to approximately 2200 K and samples with a height of up to 20 mm. A maximum of six heat shields isolating radiation reduces beam loss – this results in an enlarged external diameter of up to 400 mm. But those dimensions can not be handled at all instruments! Thus, the FRM II part of the

Sample Environment Group developed a furnace that is specifically suitable for SPHERES, the JCMS spectrometer for high energy solution. Particularly crucial were the dimensions of the furnace's middle and lower section because they meet components relevant to the instrument's function.

The challenge was to build a furnace with an external diameter of 130 mm max. that can handle samples of 40 mm lengths, and heat them up to more than 1673 K. The first difficulty was provided by the narrow character of the furnace: while it has to be heated up to this specific temperature, it also has to heat up a sample of 40 mm length homogeneously meaning that the temperature gradients have to be kept as low as possible. The required amount of three heat shields was calculated by a simulation software as well as determined by temperature and manufacturing reasons. In order to ensure a distribution of temperature as homogeneous as possible, the simulation software calculated a heating element's length of 300 mm and an inner diameter of 45 mm.

Now, the HTF can reach a temperature of up to 1873 K while samples of a maximum size of 40 x 40 mm can be used. The sample tail's extremely narrow diameter of 95 mm at the effective neutron beam makes it

possible to use the furnace for instruments that can provide only little space for sample environment.

A rack is needed to control the furnace. The furnace's heating element is powered by a power supply unit that provides a max. output current of 310 A. Temperature and temperature ramps can be monitored by a Eurotherm program control unit. A thermocouple (type C) is being used to measure the sample's temperature. Because the furnace is equipped with a water cooling system, the water's temperature is monitored by a flow meter, which measures not only its temperature but also its flow through the furnace. To prevent damage of furnace or sample, the furnace automatically turns off as soon as this temperature exceeds a certain value or when the flow falls below a particular rate. In addition, the vacuum inside the furnace is monitored.

A sample of Cobalt was used for the first experiment at SPHERES: the goal was to test a hyperfine interaction in the ferromagnetic cobalt. According to literature, the interaction should set in at 1388 K [1]. The figure below shows the temperature curve for this measurement. The sample was heated up from an initial temperature of 1073 K over a measurement period of 60 h. During the measurement with a ramp of 0,1 K/min, the temperature approached came close to the phase transition temperature.

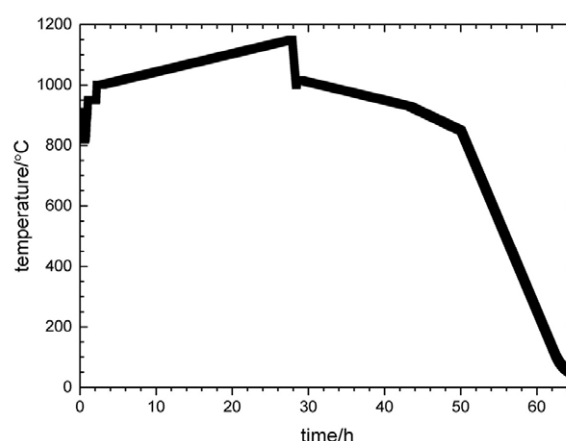

I would like to thank all my colleagues of the Sample Environment Group for their good cooperation!

*M. Antic (FRM II)*

[Read more](#)

[1] S. Deka et al., Chemistry of materials 16/ 7, p. 1168-1169 (2004)

## Only 61 instead of 112 cm height: Developing a compact cryostat

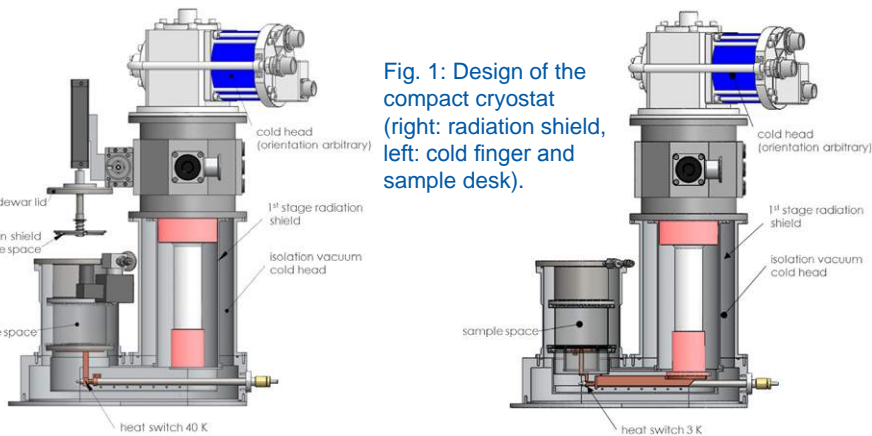

Fig. 1: Design of the compact cryostat (right: radiation shield, left: cold finger and sample desk).

To minimise dead times due to sample exchanges during neutron scattering experiments, a cryogen-free cryostat (fig.1) for automated sample exchange has been designed. The main principle is similar to standard dry-running cryostats. There are two separate vacuum chambers: the isolation vacuum on the cold head side and the sample tube. Regarding the compact cryostat, those two chambers are separated by the copper sample desk for direct thermal coupling of the sample, as well as the stainless-steel thermal decoupling of the sample desk to room temperature.

To realise a sample exchange at room temperature, the sample chamber and the cold head side can be thermally separated due to heat switches. Hence, the sample chamber can be heated and exposed to room temperature, whilst the cold head remains at low temperatures. Both, the sample desk as well as the sample tube's radiation shield can be separated from the cold head with help of those mechanical heat switches.

Additional to radiation shields, the thermal isolation of the sample-desk to room temperature is realised by evacuation of the sample chamber while cooling. Thus, the sample's temperature is lowered by direct thermal contact between sample desk and sample holder. For homogeneous cooling the sample can be put in a sealed can filled with exchange gas.

A prototype of the cryostat had been built and tested without sample. The difference between cooling it down from room temperature to less than 3 K and after a simulated sample exchange can be seen by comparison of the figs. 2 and 3. Cooling the whole system from room temperature to base temperature (< 3 K)

takes approximately 2 h (fig. 2). That is very similar to already existing dry cryostats. After a simulated sample exchange though it only takes 50 min to reach base temperature (fig. 3). Experiments with biological samples are undertaken at higher temperatures (for example 20 K). From room temperature it takes 50 min to reach 20 K (fig. 2), but with the developed compact cryostat this temperature can already be reached after 10 min (fig. 3), once the cold head is cold. This allows for a much faster sample throughput.

Despite the promising tests there are some challenges with the prototype design: due to the short distance between sample desk and the cold head's 2<sup>nd</sup> stage combined with the good thermal isolation of the heated sample desk, ice is forming on the sample chamber's sides. This can be avoided either with the help of an improved gas distribution to the sample chamber or systematic heating of the sample tube. A big challenge regarding this problem is the limited space in the sample tube for additional gas nozzles or heaters without disturbing the neutron signal.

Nonetheless, the principle of the designed compact cryostat is working as intended and with only 61 cm height (instead of 112 cm) it is more suitable for instruments with limited space.

With electrical driven heat switches and a suitable robot arm this system will allow fast automated sample exchange due to its compact design.

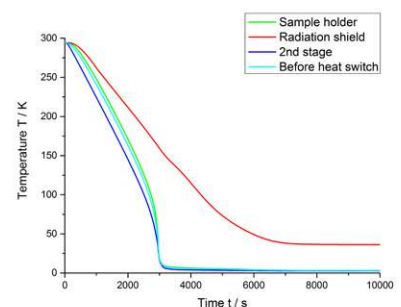

Fig. 2: Cooling curve from room temperature.

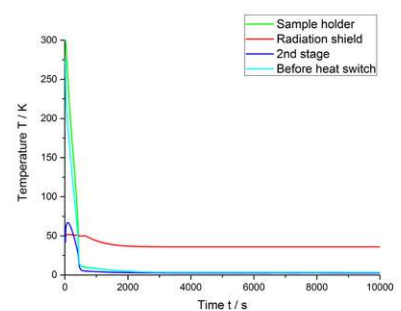
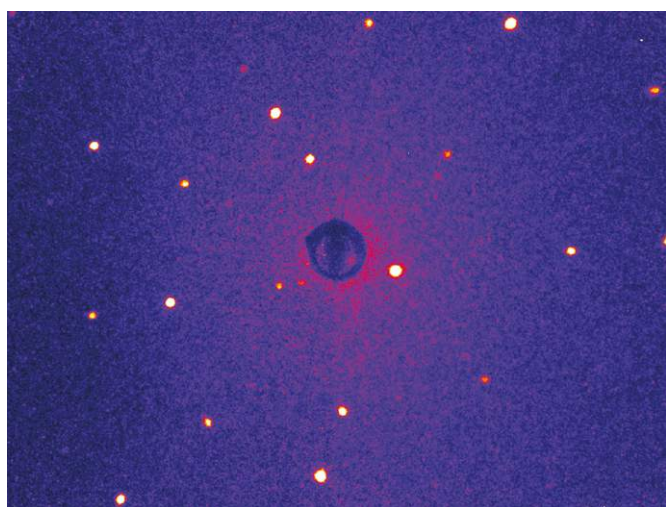

Fig. 3: Cooling curve after simulated sample exchange.

M. Resag (FRM II)

## NLaue – A fast neutron Laue diffractometer

In 2015, the new neutron Laue diffractometer started full operation – exactly 100 years after the seminal work by Max von Laue and his colleagues at the Universität München (now LMU). Max von Laue's work proved both the regular order of atoms in crystals and the wave nature of X-rays and was rewarded with the Nobel prize in 1918. Today, X-ray Laue diffraction is a standard tool for the investigation of crystal structures. Neutron Laue diffraction is less common but benefits from the neutrons' properties: the deep penetration depth as well as the ability to detect magnetic structures.



Laue image of a  $\langle 111 \rangle$ -cut diamond crystal in backscattering geometry (P. Link and B. Pedersen, FRM II).

The NLaue instrument was designed by the MPI for Solid State Research in collaboration with the MLZ. The primary purpose is the orientation and quality testing of single crystals. Individual Laue pictures are collected in a few seconds, an alignment and testing procedure takes less than one hour. Further typical applications include the study of phase transitions or the co-alignment of crystal arrays. The quantitative evaluation of diffraction data based on the Esmeralda Laue Suite (developed at the ILL) will be available in the near future. The MLZ control software NICOS allows for intuitive and easy operation of the instrument.

The set-up at MLZ uses the white thermal beam transmitted through the RESI monochromator at beam tube 8b. A sapphire filter installed inside the shutter assembly cuts the fast neutron and Gamma background. The spectrum with good intensity between 0.8 and 4 Å is suitable for experiments with a broad range of unit



© W. Schürmann (TUM)

The NLaue instrument at the thermal (white) beam. Neutrons travel from the right side through the scintillation detector (here in backscattering geometry) to the sample in the cryostat.

cell sizes. The detector (Photonic Science) is based on a  $^6\text{Li}$  doped ZnS scintillator (252 x 198 mm<sup>2</sup>) and two cooled CCD-cameras with channel plate intensifiers. A central beam tube allows to use the instrument both in forward- and backscattering geometry, where diaphragms shape the neutron beam diameter between 1 and 6 mm. The detector resolution is 2088 x 1554 pixels, the detector to sample distance is variable between 50 and 200 mm. A Huber kappa goniometer including a xyz-stage with 20 kg load capacity can carry a small cryostat (2.2 - 550 K) and allows for the scanning of larger crystals.

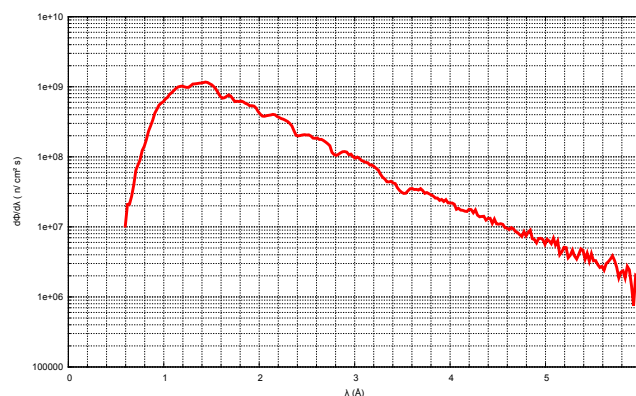

Thermal spectrum at NLaue. The small dips result from Bragg scattering in the sapphire filter and RESI monochromator (TOF electronics supplied by P. Wind, FRM II).

Fast access to the instrument with a typical preparation time of one week is possible. Please contact the instrument scientist or the MLZ User Office for details.

*T. Keller, F. Tralmer (MPI for Solid State Research)  
B. Pedersen (FRM II)*

## Now detecting much more: Upgrade of the NECTAR facility



The new detection system during commissioning phase. In the foreground is the turntable of the sample manipulator. In the upper left part the two bellows are visible, one partly hidden by a vertically fixed (green) borated PE plate used for the investigation of the influence of scattered radiation by samples. The aluminum tapes for testing the light-tightness of the housing will be removed.

The new detector system is mounted on the existing rail system of the old instrument with a new solid support structure offering the option of additional, heavy shielding against gamma radiation. On top of the support structure a 5 cm thick layer of borated polyethylene acts as base of the camera box and simultaneously shields the CCD against scattered neutrons from below, increasing the signal-to-noise ratio. The camera box was designed in an L-shaped structure with a fixed and a moving part. In the fixed component the scintillator (e.g. PP/ZnS) as well as the thin foil mirror is inherited. Compared to the old system, the scintillator can now easily be exchanged with a simple sliding mechanism instead of loosening 24 screws and removing the front cover as needed before. Another advantage of the new system is the foil mirror, which has a lower neutron interaction in front of the CCD detector and increases the signal-to-noise ratio further. The walls of the box were constructed with aluminum sheets, overlapping in the corners to ensure the light tightness of the entire box. All inner surfaces of the aluminum sheets are coated with light absorbing photo coating and plastic rivets connect the sheets among each other to allow a quick and easy disassembling in the case of service works.

The NECTAR facility is one of the first systems that went into operation after the start of FRM II in 2005. Ten years later, it was upgraded to extend the flexibility of the imaging system according to the need of the user community. The detector system was re-designed in a way, that quick scintillator exchange and field of view (FOV) selection became possible according to the requirements of the respective experiment.

The new detector system is mounted on the

The moving part of the detector box consists of a linear axis on which the CCD detector is mounted. A light-tight bellow connects the fixed part of the detector box with the CCD detector and allows a direct connection of connectors and cooling supply from outside of the housing. The movable approach was chosen for a flexible selection of the FOV, ranging from 180 x 180 mm<sup>2</sup> to 300 x 300 mm<sup>2</sup> with the standard 85 mm lens system available at NECTAR. In addition, a remote focusing unit was implemented in the upgrade to increase the performance of the instrument and an auto-focus routine is currently under development. In the absence of neutrons a small laser beamer in the housing will project pattern on the light emitting surface of the scintillator and will be used for focusing. Actually an ANDOR DV 434 and a DV 934 iKon-M CCD camera are available for measurements with the new detector set-up. The support unit for a pco.1600 camera is under construction.

During the upgrade, also the control software was exchanged with NICOS and is now similar to the control software used at the instrument ANTARES, which is the



The remote controlled focussing unit with dismounted bellow.

other tomography system at MLZ operated with cold neutrons. This allows users after an introduction to the software at one system to start much faster with experiments at the other facility. In the frame of the software upgrade, the golden ratio method was also implemented besides the equi-distant angles tomography and both methods are available as button-to-press methods. Especially the golden ratio method allows a better usage of the beam time since the tomography can be stopped any time and even in the case of problems during the experiment the acquired data can be used for reconstruction without directional reconstruction artifacts.

*S. Söllradl, T. Chemnitz, E. Calzada, C. Genreith (FRM II)  
T. Bücherl (Radiochemie München)*

## The Long Night of Science – too short anyway

This year we had a Long Night on June 27<sup>th</sup> instead of an Open Day in October. Anyway, it apparently enjoys great popularity: “only” 373 of the estimated 11 000 visitors landed a place in one of the coveted guided tours. All tours offered were already booked up at 7 pm and lasted until midnight. Many interested visitors therefore had to be rejected and asked to come separately later in the year.

The Radiation Protection Unit informed not only on the safety measures of the FRM II at its booth, but gave the visitors the chance to virtually work as a reactor operator. Playing a computer game, they (and our Scientific Director W. Petry – see the photo!) could experience how the reactor power changes with the position of the so-called control rod.

The operation principle of the instruments TOFTOF and TRISP could quite easily be explained by the two Lego models, as always an eye-catcher at the booth

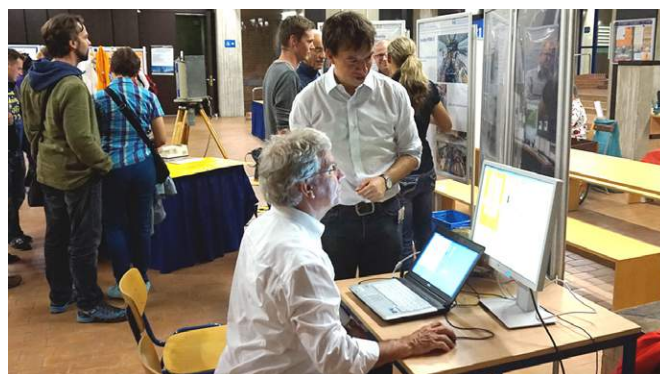

of the MLZ. The visitors were also delighted by the throwing game, in which they should hit four atoms in a crystal lattice with five neutrons. Who managed this, won a shirt. Just like in real (scientists’) lives not all tests were successful, but it was always sufficient for a small consolation prize.

Those who missed this night will have to wait until October 2016, when the next Open Day will take place.

*C. Kortenbruck (FRM II)*

## Dancing scientists at Zaragoza



Between Aug. 30<sup>th</sup> and Sept. 4<sup>th</sup>, the neutron scattering community gathered in Zaragoza in the northeast of Spain for the 6<sup>th</sup> European Conference on Neutron Scattering. A total of 652 participants came from 31 different countries –

Germany in first place, followed by France and Spain, but there were also a lot of colleagues from the Russian Federation, Japan, USA, Argentina, and even Australia.

More than 200 talks asked for an audience and three poster sessions led to fruitful discussions. These dis-

cussions’ topics changed a little bit during the conference dinner in a beautiful location at the river Ebro. Especially afterwards, when the in-house disco called for some dancing. This was really a great fun!

At the venue, the participants had the opportunity to visit the booths of all major facilities and several companies. The MLZ organised a joint booth together with the Helmholtz-Zentrum Berlin (HZB) where the German neutron facilities were presented. We got a lot of visitors with even more questions – and what a surprise, they mostly deal with the MLZ proposal deadline one week later!

*I. Lommatzsch (FRM II)*



## DyProSo XXXV: Four days of dynamic discussions

Since nearly half a century, the European community of scientists working on the **D**ynamical **P**roperties of **S**olids have been meeting annually or biannually, typically in a nice and tranquil location in order to stimulate the contact between the participants. From Sept. 13<sup>th</sup>-17<sup>th</sup>, this year's DyProSo XXXV incarnation took place on Freising's Domberg, a site of eminent historical significance.

Even though global politics broke into our ivory tower in the form of the cancellation of train services on the main railroad towards the east, in the end all 76 participants from 13 European countries as well as three scientists from overseas succeeded in joining us and gave 15 invited lectures, 29 contributed talks, and 18 poster presentations on topics such as multiferroics, diffusive dynamics, correlated electrons, and phonons.

While a sizeable fraction of participants is already using neutron scattering techniques, the experimen-



tal capabilities presented during the optional tour of the FRM II spawned additional potential users. The alternative of a guided tour of the Domberg's historical buildings was also well received. As was revealed during the conference dinner at the Bräustüberl Weihestephan, the next installment of the DyProSo series will take place in Poland in 2017, and without a doubt it will be as successful as this year's one.

*M. Leitner (FRM II)*

## JCNS LabCourse: Learning neutron scattering!

The 19<sup>th</sup> JCNS Laboratory Course Neutron Scattering took place Sept. 7<sup>th</sup>-18<sup>th</sup>, held at Forschungszentrum Jülich for the lecture part and at the MLZ for the experiments.

The labcourse is open to students world-wide of physics, chemistry, and other natural sciences. The course is part of the curricula of the Universities of Aachen and Münster. Participation is free of charge. Financing came from Forschungszentrum Jülich with support from the EU projects NMI3, ESMI, and SoftComp.



The first week of the course was dedicated to lectures and exercises covering the technical basics of neutron scattering and selected topics of condensed matter research.

In the second week, eleven instruments at MLZ were made available for students' training. These world-class instruments were provided by JCNS, TUM, RWTH Aachen, University Göttingen, and Karlsruhe Institute of Technology.

This year, 55 students were selected from 132 applicants. 20 foreign students came from a total of 14 countries. As in the years before, the participation of female students was high, this year 47%.

The next JCNS laboratory course will take place September 5<sup>th</sup>-16<sup>th</sup>, 2016. You are invited to submit applications at [www.neutronlab.de](http://www.neutronlab.de) (open from January 2016).

*R. Zorn (Forschungszentrum Jülich)*



## JCNS-Workshop 2015 attracted key experts and specialists from all over the world



“Neutron Scattering on Nano-Structured Soft Matter: Synthetic- and Bio-Materials” was the focus of this year’s JCNS Workshop, held from Oct. 5<sup>th</sup>-8<sup>th</sup> at the Evangelische Akademie Tutzing. The workshop was jointly organised by the JCNS and the Donostia International Physics Center (DIPC), San Sebastian, Spain. Financial support was gratefully received from SoftComp and ESML.

71 attendees from Europe, Israel, the USA, and Japan joined the event. 42 talks were given and 16 posters were presented. The workshop addressed a diversity of different topics to which neutron scattering has made significant contributions. Neutrons provide a fundamental understanding of the structure and dynamics of materials. Composite materials with soft and hard fillers or frameworks provide new pathways for designing advanced materials. Complex polymer architectures such as star polymers or ring polymers were highlights of the workshop. Insights into the functioning of intelligent and responsive materials such as microgels were presented. Among the biological applications, membrane proteins proved to be an outstanding topic of research, where contrast variation allows details to be studied to a degree unobtainable using other techniques. Soft matter materials for sustainable energy use is a topic with huge future potential.

The JCNS Workshop 2016 (Oct. 4<sup>th</sup>-7<sup>th</sup>) will be dedicated to hard matter materials.

*H. Frielinghaus, O. Holderer and R. Bruchhaus  
(JCNS)*

## 25 scientists attended workshop “Soft Matter and Neutrons GO Energy”

The first Jülich Workshop on “Soft Matter and Neutrons GO Energy” took place in Feldafing from Oct. 8<sup>th</sup>-9<sup>th</sup>. Twenty-five scientists exchanged ideas in an interdisciplinary environment on topics related to soft matter and neutron research for sustainable energy supplies. The event, organised by the Jülich Centre for Neutron Science (JCNS) and the Institute of Energy and Climate Research - Electrochemical Process Engineering (IEK-3, Forschungszentrum Jülich), was held in the GIZ Conference Centre (Deutsche Gesellschaft für Internationale Zusammenarbeit).

The workshop hosted sessions on batteries, on materials relevant for diverse energy-related applications from solar cells to new types of rubber for tyres, as well as on fuel cells. Lively discussions resulted from the different sessions, showing that energy-related topics and neutron scattering form a very attractive combination, for example for “in situ” or “operando”

studies of batteries and fuel cells. Many different techniques available at the MLZ have been used in the different contributions, from GISANS to neutron radiography, from QENS to diffraction.

*O. Holderer, R. Bruchhaus (JCNS)*



## NMI3-II and SINE2020: Strong support by the EU on access and development of neutron science at MLZ

To strengthen the European Research Area, the European Commission continues the strong support of neutron scattering in Europe within the Framework Programmes FP7 and HORIZON2020.



The NMI3-II access programme provided European users with direct financial support for doing experiments at MLZ.

The funding of 1.63 Mio€ covered the access, travel costs, and subsistence of some hundred experiments by European users at the instruments at the FRM II since 2012. The tremendous success of the NMI3-II programme was highlighted at the general assembly of the project in Copenhagen last month with more than 140 participants. During the meeting the manifold activities in joint research activities of the NMI3-II programme beyond offering access to users were presented.

Within the project, MLZ has been in charge of all dissemination and outreach activities like providing the programme's webpage [nmi3.eu](http://nmi3.eu), and taking care of newsletters, workshops as well as brochures. A special activity was the development of a neutron e-learning platform. TUM and JCNS also worked in various technical activities of the NMI3-II programme:

- development of neutron imaging with grating interferometers, high resolution imaging, and energy-selective imaging (TUM),

- magnetic 3D-SANS and imaging in thin films (JCNS),
- development of the MIEZE technique (TUM),
- choppers for ESS instrumentation (JCNS),
- in-situ devices in soft matter (JCNS),
- novel concepts for scintillation neutron detectors (FZJ),
- $^{10}\text{B}$  converters in gas detectors (TUM).

While the meeting described the success of the NMI3-II programme which ends in January 2016, the next programme to support the development of neutron scattering was launched also in Copenhagen. On Oct. 1<sup>st</sup>, 2015,



the project for **Science and Innovation with Neutrons in Europe**, SINE2020, started. The four-year project with a budget of 12 Mio€ and 18 partners continues various activities on technical and methodological subjects in neutron scattering as well as outreach and dissemination towards science and industry. SINE2020 aims to ensure that the novel research opportunities and the innovation potential at the European Spallation Source ESS, currently under construction, will be put to optimal use from the very beginning.

Activities of MLZ in SINE2020 are

- dissemination and outreach activities (TUM),
- deuterated polymer synthesis (JCNS),
- characterisation of protein crystallisation processes (JCNS),
- sample environment devices (HZG and TUM),
- detector development (FZJ, TUM),
- development of analysis software (JCNS).

Furthermore, a dedicated work package within the project organised by HZG aims to increase the interaction with and involvement of industry in the use of neutrons. The total funding of these activities at MLZ reaches 2.3 Mio€ within four years.

*T. Gutberlet (JCNS)*



## NFFA-EUROPE: An open access resource for experimental & theoretical science



NFFA-EUROPE is an open access platform, granted by the EU for 48 months from Sept. 1<sup>st</sup>, 2015, to carry out comprehensive projects for multidisciplinary research at the nano-scale extending from synthesis to nano-characterisation to theory and numerical simulation.

20 NFFA-EUROPE partners make available advanced resources. Those are specialised on growth, nano-lithography, nano-characterisation, theory, simulation, and fine-analysis with synchrotron radiation, free electron laser (FEL) and neutrons. They are integrated to develop frontier research on nanoscience and to enable European scientists from diverse disciplines to access state-of-the-art and unique methods and tools.

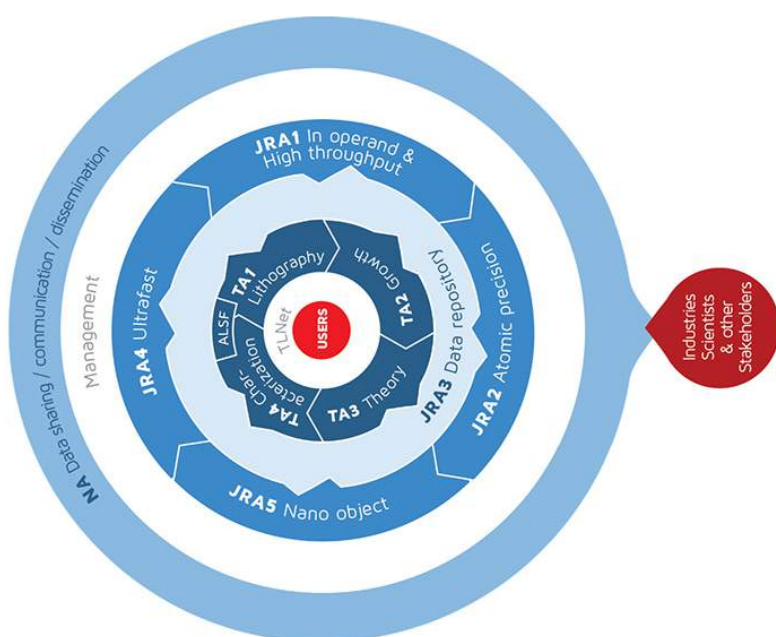

NFFA-EUROPE enables coordinated **transnational access (TA)** to nanoscience laboratories, half of which are co-located with large-scale infrastructures for fine analysis, or linked to **high-performance computing (HPC)** facilities as well as **joint research activities (JRA)** and **networking activities (NA)**.

The access management structure optimises the services for the users to pursue scientific excellence as well as industrial and technological innovation. Proposals for all NFFA-EUROPE methods and instruments can be submitted via a single entry point at the [nffa.eu](http://nffa.eu) portal. A panel of international experts is in charge of the peer-review selection to ensure the scientific excellence and/ or innovation potential of the accepted proposals. Moreover, the experts of the **technical liaison network (TLNet)** are always in dialogue with the user and assist him from the proposal submission via the technical feasibility check to the personalised access programme optimising the use of the NFFA-EUROPE infrastructure.

At MLZ, the NFFA-EUROPE offers access to the molecular beam epitaxy method for thin film fabrication as well as to selected neutron scattering instruments.

*F. Carsughi (JCNS)*

### Read more

Additional information is available at [www.nffa.eu](http://www.nffa.eu)

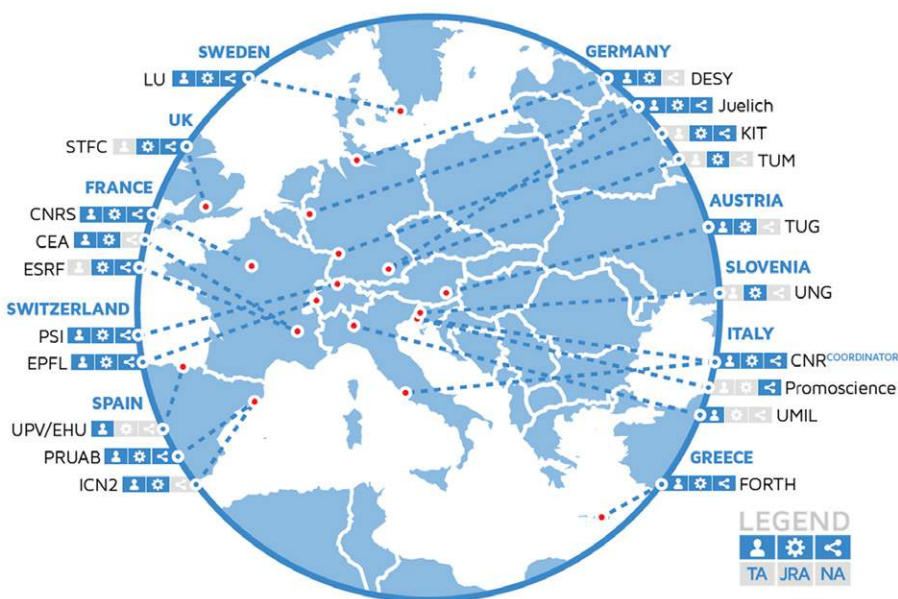

## News from the KFN



Tobias Unruh  
Chairman of the 10<sup>th</sup>  
Komitee Forschung mit  
Neutronen (KFN)  
Tobias.Unruh@fau.de

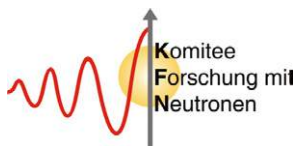

Dear friends,

the new call for collaborative research projects was published on September 17<sup>th</sup> by the BMBF with the November 1<sup>st</sup> as deadline. It was a tough job for all applicants to finish the applications in time, but now we are done and this time well before Christmas. Although the official numbers are not yet published, a strong contribution from the neutron community becomes apparent.

This year, an in-depth evaluation of the collaborative research has been started. The KFN strongly supports this process with the aim to set up a so-called 'Fachprogramm' in the BMBF for this well established and essential tool. It efficiently supports the involvement of university research groups into instrumentation at national large scale research facilities. The KFN is convinced that the outcome of the evaluation will demonstrate the excellent output and outstanding effectiveness of this funding tool. I would like to ask you to support the evaluation process with all your strength.

I also would like to remind you to reserve September 20<sup>th</sup> to 22<sup>nd</sup>, 2016, for the upcoming German Neutron Scattering Conference in your next year's schedule. The conference will take place in the Auditorium Maximum of the Christian-Albrechts-University of Kiel [1]. The preparation of the conference is already in full swing and of course a call for the next Wolfram-Prandl-Prize will also come in spring 2016.

I would like to inform you about the ENSA lobbying initiative at a Neutron Scattering Day in Bruxelles on February 4<sup>th</sup>, 2016, where the fundamental importance of research with neutron for solving the scientific and technological challenges of the European society will be demonstrated. In this context, ENSA has finalised a brochure on 'Neutrons for science and technology' with a substantial contribution of MLZ. The brochure can also be downloaded from the KFN web page [2].

Finally, I would like to wish Merry Christmas and a Happy New Year to all of you. I am looking forward to exciting new research with neutrons and seeing you in 2016!

### Read more:

[1] [www.sni-portal.de/dn2016/index-engl.php](http://www.sni-portal.de/dn2016/index-engl.php)

[2] [www.sni-portal.de/kfn/Archiv/20150723\\_ensa-ecns-broschuere\\_s.pdf](http://www.sni-portal.de/kfn/Archiv/20150723_ensa-ecns-broschuere_s.pdf)

## Newly Arrived



*Volodymyr Baran*

I recently joined the team at SPODI and will support users there. My scientific research will be concentrated on the investigation of lithium ion batteries. Before, I obtained my PhD at the TUM Chemistry Department. My previous scientific work was related to characterisation of intermetallic clathrates of thermoelectric applications and to Li-rich silicides for energy storage applications. My research interests are primarily energy related materials and systems, in particular lithium ion batteries and materials used in them.

+49-89-289-14373  
volodymyr.baran@frm2.tum.de

*Zachary Evenson*



I am currently the other half of the scientific team on TOFTOF. Directly before coming to the MLZ, I was at the German Aerospace Center in Cologne where I specialised in microscopic structure and dynamics of levitated liquid metals. I am interested in almost everything related to liquid metals, metallic glasses, and glassy dynamics. Along with its long-standing history in the area of viscous metallic liquids, the unique capabilities of TOFTOF make it particularly well suited for my research interests.

+49-89-289-14975  
zachary.evenson@frm2.tum.de

From Forschungszentrum Jülich I moved southwards and joined the outstation at Garching to run the JCNS part of the Sample Environment Group. Here I want to focus especially on the development of novel equipment. During my time as a postdoc in Jülich, I was responsible for an oxide molecular beam epitaxy and did research on thin film interfaces of Perovskites. Because I worked in the field of magnetisation dynamics, my major interest goes to magnetism in general. Beyond that, novel materials with multiferroicity interest me as well as instrumentation in general.



*Alexander Weber*

+49-89-289-10726  
al.weber@fz-juelich.de



*Coming soon!*

## Peeking through the keyhole: Opening the reactor's primary cell

The so-called primary cell ("Primärzelle") is a watertight room in the reactor building. Among other components, it houses the primary pumps and the primary/ secondary cooling loop heat exchangers as well as the moderator leakage detection system.

Due to the rules for radiation protection, the primary cell is not accessible during reactor operation. However, regular access is required during maintenance breaks. The cell's lid consists of several concrete bars, the biggest one weighing more than 8 T. In order to open the cell, they have to be removed. This is quite a delicate manoeuvre: space is very limited and don't forget the vicinity of the hot cell's fragile manipulators! Afterwards, a scaffolding has to be prepared as a temporary work place in front of the hot cell.

This tricky job is always entrusted to the hands of the skilled members of the groups Internal Transport ("Förder-technik") and Workshop ("mechanische Werkstatt").

Let's have a look!

*A. Pichlmaier (FRM II)*

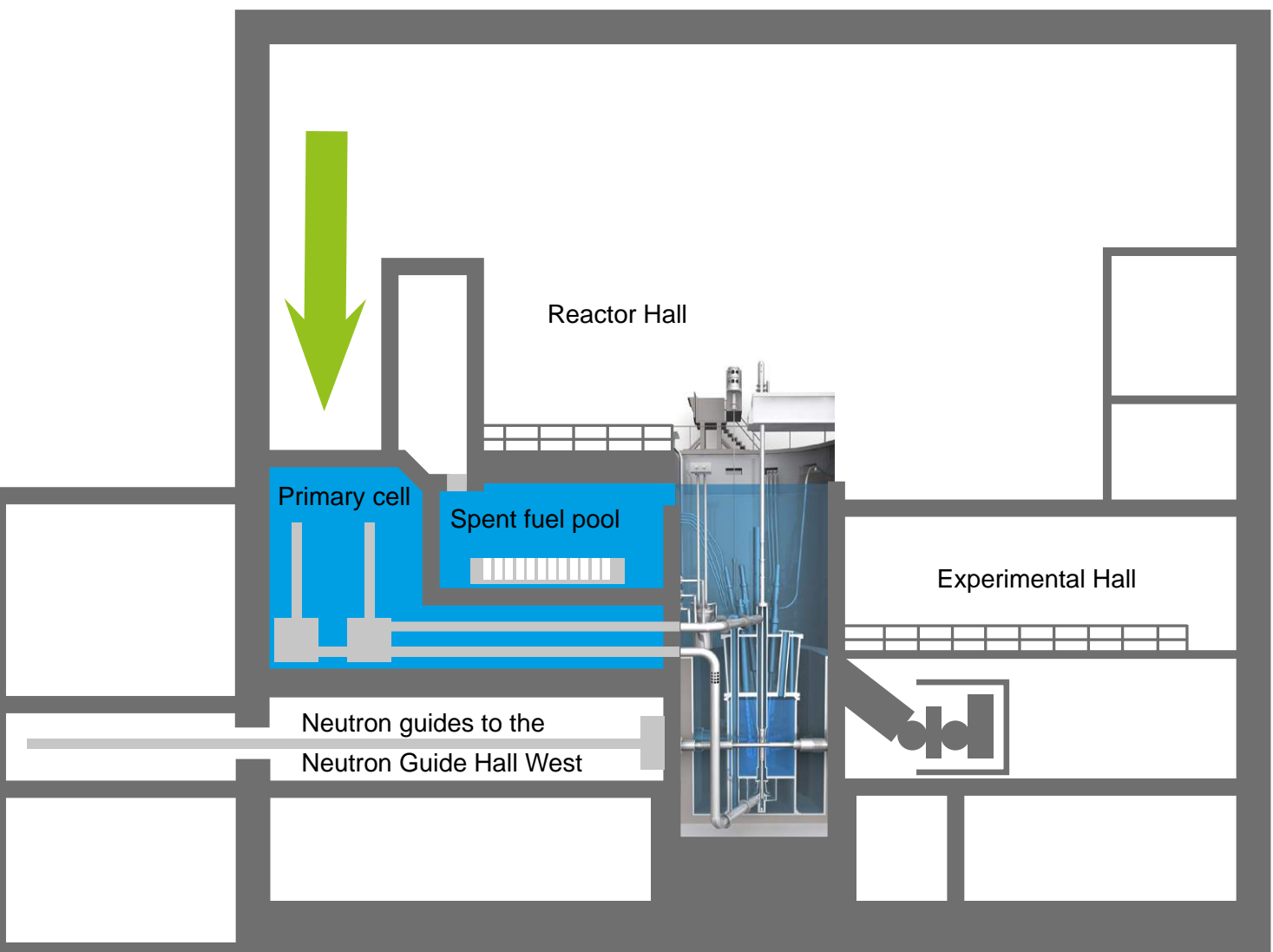



## News from the User Office

### Proposal round 20

351 proposals requesting a total of 2196 beam days were submitted for the second proposal round in 2015. By adding up both proposal rounds of the current year, the total number of submissions is the largest ever with an increase of about 12% comparing to 2013 (that was the last year with two proposal rounds).

About one half of the proposals were submitted by German scientists, one third by other European colleagues, and the remaining ones by American and Asiatic researchers. As far as the scientific field is concerned, the largest number of proposals was submitted to magnetism, followed by soft condensed matter, material science, biology, and condensed matter physics: these five scientific fields contained about 87% of the submitted proposals.

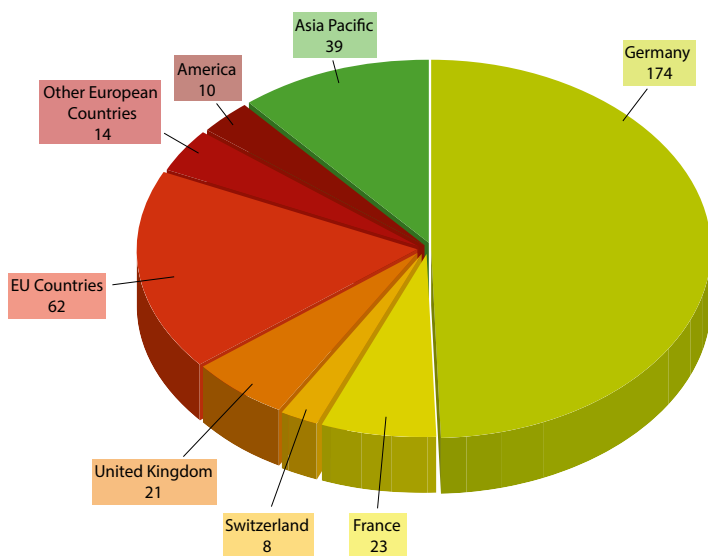

The proposal submission deadline was on September 11<sup>th</sup>, 2015, and after taking some weeks for the online voting, the members of the seven MLZ review panels met for the final assessment on October 22<sup>nd</sup> and

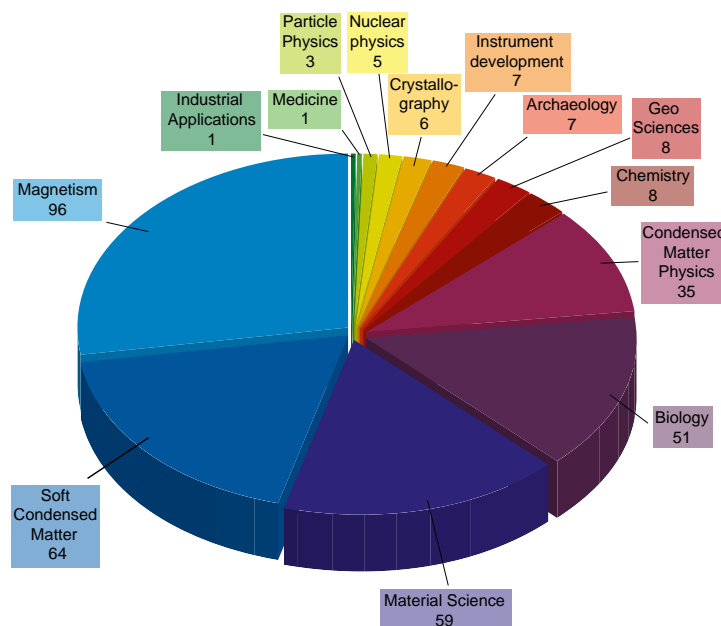

23<sup>rd</sup>, 2015. The ranking suggested by the MLZ review panels was afterwards processed by the User Office, taking into account missing experimental reports: the lack of such a report for a former experiment leads to a deduction of points. Finally, the MLZ directorate approved the results of the round and thus, the users could be informed via email.

Almost 80% of the submitted proposals could be accepted. This resulted in the allocation of about 66% of the requested beam time. Regarding the submitted proposals, the most requested instruments were the small angle scattering diffractometer KWS-2 and the materials science diffractometer STRESS-SPEC: 33 proposals asked for beam time at the first one, 32 at the latter. Looking at the requested beam time, the most requested instrument was the diffractometer for large unit cells BIODIFF with 200 requested days. The average overbooking factor on all MLZ instruments is 1.5, being the largest one 2.0 on BIODIFF.

**Proposals:  
May 06<sup>th</sup>, 2016**

**Upcoming**

Find all information at



Each MLZ review panel consists of eight to twelve members and we ask our referees to be on duty for three years. Therefore there are always some new members to welcome at each meeting. This time, this was the case for six new referees in five of the panels.

### Rapid Access programme 2013-2015

In 2013, the Rapid Access programme was established for the benefit of our users. This fast possibility is devoted to special cases, such as, for example, the completion of a previously performed measurement with a few samples for a publication or the feasibility measurement for the preparation of a proposal to be submitted to the MLZ instruments. Each instrument does not allocate more than 5% of its total beam time to the Rapid Access programme and the maximum beam time for such a proposal is therefore limited to twelve hours.

Since its start, three instruments have been available within the Rapid Access programme:

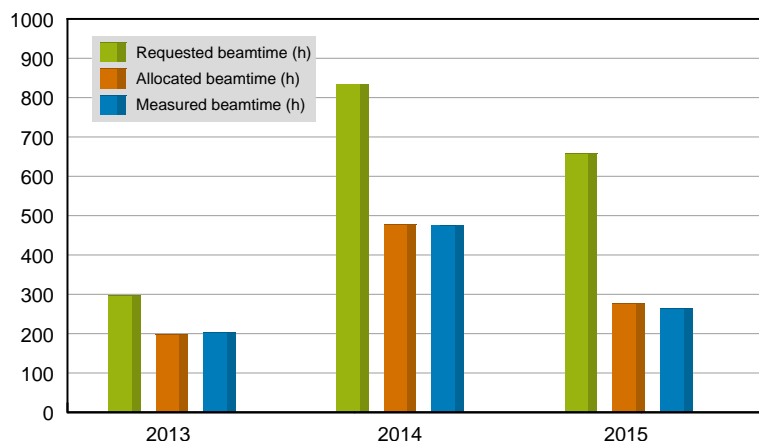
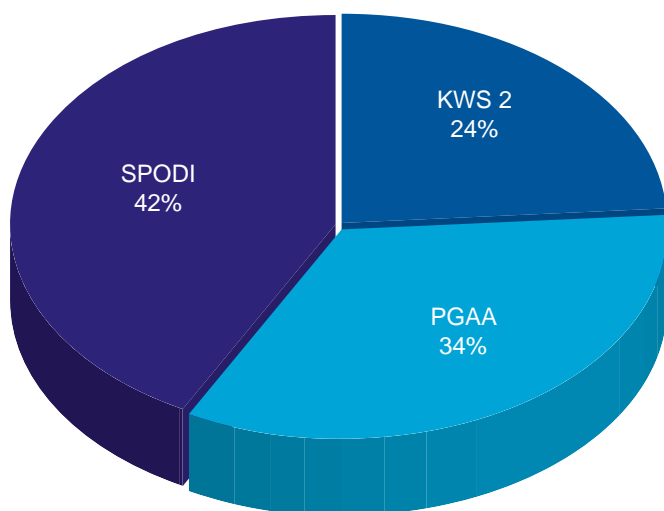

- the small angle scattering diffractometer KWS-2,
  - the prompt gamma activation analysis instrument PGAA, and
  - the high resolution powder diffractometer SPODI.
- Since a few months, a fourth instrument is included in the Rapid Access programme: the diffractometer for large unit cells BIODIFF.

Since the start of the MLZ Rapid Access programme, 109 proposals have been submitted and requested a total of 1788 hours of beam time. In total, 952 hours of beam time were allocated of which 945 have been measured. The difference between requested and allocated beam time results in an overbooking factor of 1.9. SPODI is the most used instrument within this programme, delivering 42% of the allocated hours.

The response of the MLZ users is very positive, because the Rapid Access programme shortens the minimum access time to selected MLZ instruments from about three months down to a couple of weeks when compared to the normal proposal procedure! Generally four times per year, the users get their chance: the Call for Rapid Access proposals is published before each reactor cycle.

## deadlines

[mlz-garching.de/user-office](http://mlz-garching.de/user-office)

## Rapid Access proposals: February 23<sup>rd</sup>, 2016

## Upcoming

### February 22 – March 04

47<sup>th</sup> IFF Spring School  
(Jülich, Germany)  
[www.iff-springschool.de](http://www.iff-springschool.de)

### March 06 – 11

DPG Spring Meeting  
(Regensburg, Germany)  
[regensburg16.dpg-tagungen.de](http://regensburg16.dpg-tagungen.de)

*Visit our booth there!*

### July 04 – 07

International Conference on Polarised Neutrons for  
Condensed Matter Investigations (PNCMI)  
(Freising, Germany)  
[www.fz-juelich.de/jcns/PNCMI2016](http://www.fz-juelich.de/jcns/PNCMI2016)

### July 18 – 21

Neutrons for Energy  
(Bad Reichenhall, Germany)  
<https://webapps.frm2.tum.de/indico/e/neuforenergy>  
(Registration starts on January 15<sup>th</sup>, 2016)

## Reactor Cycles 2015

No.	Start	Stop
39	08.03.2016	06.05.2016

Please note that the FRM II went into a longer maintenance break on October 20<sup>th</sup>, 2015. This break is necessary in order to carry out extensive work on the neutron supply for the new Neutron Guide Hall East.

Please be aware that the planned restart on March 8<sup>th</sup> could be shifted.

Further cycles will be announced.

Please check our web site [mlz-garching.de/user-office](http://mlz-garching.de/user-office) and our blog [mlz-garching.de/englisch/user-office/blog.html](http://mlz-garching.de/englisch/user-office/blog.html) for updates!

## Imprint

### Editors

Rainer Bruchhaus  
Flavio Carsughi  
Connie Hesse  
Christine Kortenbruck  
Ina Lommatzsch  
Jürgen Neuhaus

### Layout and Typesetting

Ramona Bucher  
Ina Lommatzsch

### Picture Credits

Front cover, p. 2-3: W. Schürmann, TUM  
Back cover: B. Ludewig  
If not indicated: By editors, authors, and/ or MLZ.

### Contact

Forschungs-Neutronenquelle  
Heinz Maier-Leibnitz (FRM II)  
User Office  
Lichtenbergstraße 1  
D-85747 Garching  
Phone: +49.(0)89.289.10794  
10703  
11751  
Fax: +49.(0)89.289.10799  
e-mail: [useroffice@mlz-garching.de](mailto:useroffice@mlz-garching.de)  
[www.mlz-garching.de](http://www.mlz-garching.de)



Wow...

Photo by H. Kolb (FRM II)

