



Newsletter

17

MLZ is a cooperation between:

The Heinz Maier-Leibnitz Zentrum (MLZ):

The Heinz Maier-Leibnitz Zentrum is a leading centre for cutting-edge research with neutrons and positrons. Operating as a user facility, the MLZ offers a unique suite of high-performance neutron scattering instruments. This cooperation involves the Technische Universität München, the Forschungszentrum Jülich and the Helmholtz-Zentrum Geesthacht. The MLZ is funded by the German Federal Ministry of Education and Research, together with the Bavarian State Ministry of Education, Science and the Arts and the partners of the cooperation.

Bavarian State Ministry of
Education, Science and the Arts



SPONSORED BY THE



Federal Ministry
of Education
and Research



Collaborative Neutrons

An editorial by

Supporting the research on condensed matter systems at large scale infrastructures is a success story for many years in Germany. By a dedicated research funding scheme (“Verbundforschung”), the Federal Ministry of Education and Research enables groups from German universities to develop instrumentation and analysing methods at large-scale research infrastructures in order to exploit the usage of these facilities. Neutron, synchrotron, and ion beams are used at the large scale facilities. The “Verbundforschung” of the BMBF thus fosters the collaboration of university groups with large-scale research infrastructures in order to achieve their optimal use. Exploring the innovation potential and training of young researchers on these advanced experimental techniques is achieved by open calls for methods and instrumental development projects. A special focus is given to relating these technical and methodical developments to actual research topics like nano-technology, microelectronics, new materials, energy, or life sciences.

The Research Neutron Source Heinz Maier-Leibnitz (FRM II) and its scientific exploitation by the cooperation in the MLZ institute is of key importance for the German neutron user community. The long term perspective of the FRM II will grant a solid home base for German neutron users, which is reflected by the numerous applications for development projects at the recently started funding period 2016 – 2019. Right from the beginning of the instrument construction at the FRM II, the BMBF has supported the development of highly innovative instruments and instrument upgrades. As a benefit a unique close link from university groups to a large scale facility has been achieved.

*Collaborative research funding
to enable collaborative success!*



*Dr. Ralph J. Dieter
Chair of the governing body MLZ
Federal Ministry of Education
and Research
Referat 711*

Read more

in our feature

*New Collaborative Research
projects: Verbundforschung
2016 – 2019 at the MLZ*

from p. 5 on!

- 05 • New Collaborative Research projects: Verbundforschung 2016 – 2019 at the MLZ

SPECIAL FEATURE

- 11 • Evolutional upgrade of KWS-3
- 12 • New set-up at PGAA
- 13 • Magnetic field at TOFTOF

INSTRUMENTATION

- 14 • Neutrons For Energy
- 14 • More than 120 participants attended PNMCI 2016
- 15 • Celebrating 50 years of backscattering
- 16 • Sketchnote by Rob Dimeo
- 18 • Local events with the MLZ
- 19 • German neutron scattering community gathered at Kiel
- 19 • Workshop on SoNDe Application in Neutron Detection at Freising
- 20 • 6th VDI-TUM Experts Forum: Focus on high performance materials
- 20 • First BornAgain School gave input for further development
- 21 • First Joint Workshop JCNS and FLIPPER
- 21 • 20th JCNS Laboratory Course Neutron Scattering

EVENTS

- 22 • Joining forces for neutron imaging: The Neutron Imaging Group at MLZ

SCIENCE & PROJECTS

- 24 • New projects – new colleagues!
- 25 • Newly arrived at the instruments
- 25 • Wolfram-Prandl-Prize to Anatoliy Senyshyn
- 26 • Smooth transition in FRM II administration

INSIDE

- 27 • Call for proposals
- 28 • Accompanying users and training at the lab
- 29 • New form for dose history of foreign scientists
- 30 • Upcoming
- 30 • Reactor cycles 2017

USER OFFICE

New Collaborative Research projects: Verbundforschung 2016 – 2019 at the MLZ

SPONSORED BY THE



Federal Ministry
of Education
and Research

Building new and upgrading operating instruments is a continuous process established at the MLZ since the start of user operation. A significant part of this endeavour

is realised by research and development projects of German universities supported by the Federal Ministry of Education and Research (BMBF) via the so called “Collaborated Research” (Verbundforschung) programme. This funding scheme supports university groups developing methods and instruments for the usage at German large scale infrastructures. The funding periods usually extend over three years. Recent projects in the condensed matter research section have started in July 2016.

25 projects related to the MLZ have been submitted in 2015 with a total investment of about 27 Mio€. The scientific and technical evaluation was organised by the funding organisation BMBF, whereas aspects of the integration in the MLZ instrument suite were assessed with the help of the Instrument Advisory Committee of the MLZ. Out of these applications, 19 projects were approved for funding with an investment volume of 13.5 Mio€ for a period of three years. They cover the section neutron research as well as research with ion beams, i.e. in the case of MLZ applications of positron beams.

New instruments

Three new instruments are currently under development or already in cold commissioning, respectively received funding for completion. The extreme environment, time-of-flight diffractometer **SAPHIR** using a multi-anvil press is built by the Bavarian Research Institute of Experimental Geochemistry and Geophysics (BGI) of the University of Bayreuth. Its aim is to investigate geological samples under high pressure and high temperature. The instrument has already been assembled in the New Neutron Guide Hall East and is (like others) urgently waiting for neutrons to start hot commissioning. Actual work comprises the completion of the remaining detector area and commissioning of the instrument control. A challenging development

aims to increase the maximum pressure at the sample position from 15 GPa to 25 GPa by means of new anvil geometries with sintered diamond tips.

The three axes spectrometer (TAS) **KOMPASS** is currently built up at the end position of the neutron guide NL1 in the Neutron Guide Hall West. The instrument team of the II. Physikalisches Institut, University of Cologne and Physics Department, Technical University of Munich aims to develop a TAS using cold neutrons with permanent polarization which is optimised for (spherical) polarization analysis. Using a triple cavity together with variable focussing guide optics, a velocity selector and large double-focussing monochromators and analysers, the instrument will be perfectly optimised for the investigation of complex magnet systems. The funding period will mainly cover the instrument’s installation and commissioning. Further developments are looking for an extension towards time resolved experiments, optimisation to perform experiments on small samples as well as the development of special environments for complex structures. Exploring future spin-echo options will be done in close collaboration with the Max Planck Institute for Solid State Research in Stuttgart.

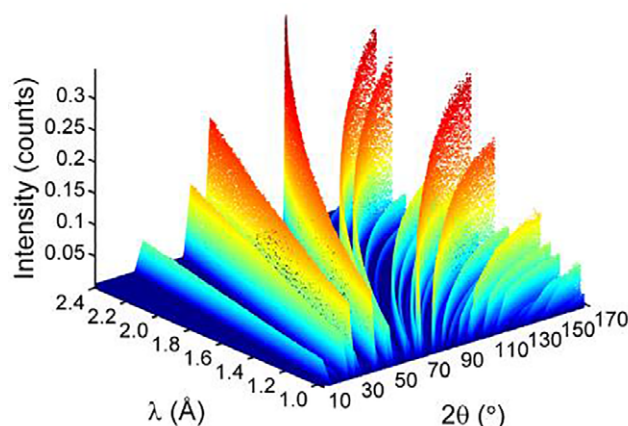

Simulated diffraction pattern for PowTex.

The third instrument under construction is the time-of-flight diffractometer **PowTex** built by the institute for Solid-State and Quantum Chemistry, RWTH Aachen in close cooperation with the Forschungszentrum Jülich and the Geowissenschaftliches Zentrum, Georg-August-Universität Göttingen. It aims to provide a high flux diffractometer with special focus on small samples from chemistry as well as textured sample from the

geoscience and materials science community. Major challenges were the maximised coverage with neutron detectors which implied a newly developed technique with ^{10}B -detectors which are under production actually. Besides the engineering of the entire detector, the software development for the complex 3D data analysis has already achieved tremendous progress. The majority of the key components are already available. Major task for the new funding period will be the installation of the instrument in the Guide Hall East including all commissioning steps. Additional developments will focus on complex sample environment for in-situ studies at high pressures as well as high temperatures.

Upgrades and new methods

The largest portion of the projects deals with the improvement or extension of already operating instruments. The goals are to implement new experimental techniques or to increase the performance of the experiments.

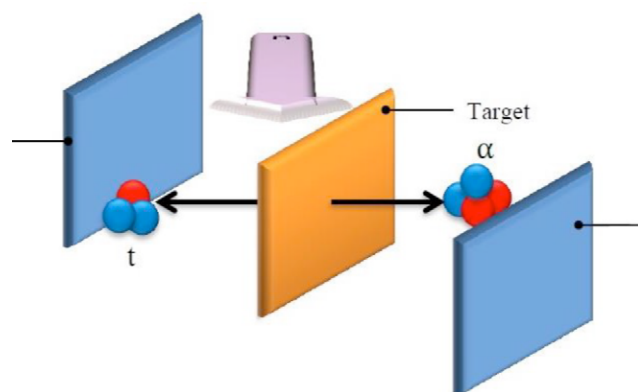

PGAA: Sketch of the Neutron Depth Profiling set-up.

As an extension of the prompt gamma activation analysis a new analytical method, the Neutron Depth Profiling will be developed for the **PGAA** facility. In collaboration of the Physics Department and the FRM II of the Technical University of Munich the required detection system for α -particles will be developed. The scientific interest stems from the analysis of strong neutron absorbing materials like boron or lithium as a function of penetration depth from the sample surface. The energy of the detected α -particles serves as a measure of the absorption depth and provides an ex-

treme sensitivity in the order of 10^{-9} with a depth resolution of about 20 nm. The high intensity of the neutron beam at the PGAA facility will enable to measure these profiles in seconds allowing the study of in-situ processes for example at the intercalation of lithium in the cathode of a Li-ion battery.

Using thermal neutrons at the **NECTAR** facility is the aim of a project of the Institute for Applied Materials, Energy Storage Systems at the Karlsruhe Institute of Technology (KIT). The radiography and tomography station NECTAR is provided with fast neutrons from the converter facility of the FRM II. In order to bridge the gap between these fast neutrons on one hand and the cold neutron beam at the imaging facility ANTARES on the other hand the NECTAR instrument will be operated without the converter facility. The development program is focussed on an optimised set-up for imaging experiments with thermal neutron using a high resolution detection system and software developments to combine thermal and fast neutron radiography in a so far unique way. Special attention will be given to a fine tuned shielding concept on the neutron flight path and detector system. Applications in view comprise energy storage systems (batteries) to reveal mechanisms of fatigue or electrolyte dynamics.

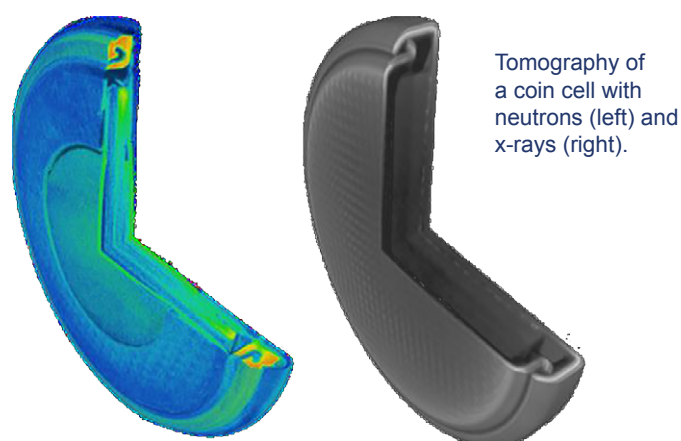

NeuRoFast is acronym of the project to improve the imaging possibilities at the instrument **ANTARES**. Based on the outcome of a successor project (NeuRoTom) the complementary properties of neutron and X-ray tomography in view of contrast and resolution will lead to new insights into technical objects and kinetic processes. It aims to improve the spatial and temporal resolution by a novel neutron detector system. The

applied imaging methods comprise multi-modal X-ray, neutron phase contrast, and dark field imaging. The collaborating groups from the Technical University of Munich and University Freiburg intend to perform in-operando experiments and novel contrasting methods for electrolysis and redox flow battery systems.

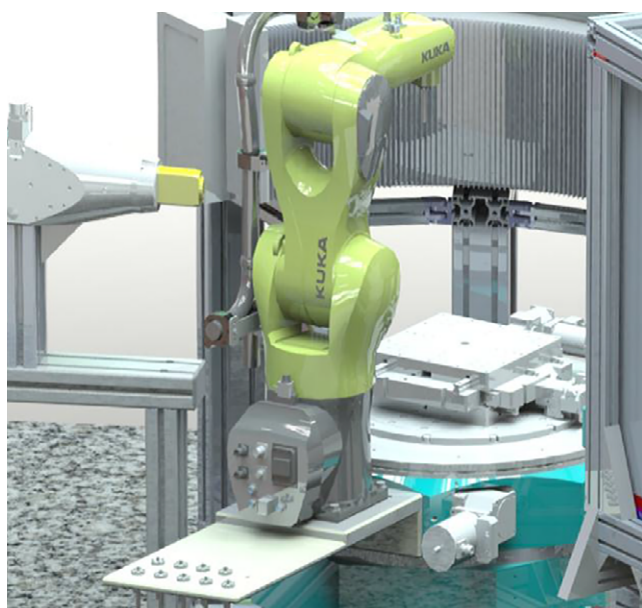

Robotic sample positioning provided by the ERWIN project.

The increasing demand of high throughput neutron diffractometers is not well covered by the actual instrument suite of the MLZ. Whereas high resolution powder diffraction is served well at the instrument SPODI, strain scanning and texture measurements are provided at STRESS-SPEC. The instrument PowTex under construction (see above) will provide additional capacity, its time-of-flight mode and design is optimised for certain types of applications. This leaves room for a further high power diffractometer with constant wavelength, large continuous area detector, and easy access to the sample position for complicated and frequently changing vast sample environment. The group from the Institute for Applied Materials, Energy Storage Systems at the KIT will improve the set-up at the thermal neutron diffractometer **RESI**, so far mainly used for single crystal diffraction. The goal of the project called ERWIN is to collect data of neutron diffraction pattern from a standard sample of about 1 cm³ in volume in the range of minutes. This will allow multi-parametric studies and kinetic experiments especially for electrochemical energy storage sys-

tems and energy-related materials at real operating conditions. Using a small gauge volume, spatially-resolved diffraction will be possible which in addition is advantageous for the suppression of background for example for high pressure experiments.

Attracting new users to neutron diffraction with samples much smaller than 1 mm³, performing studies on samples ten times smaller than usual with neutron wavelength $\lambda < 1 \text{ \AA}$ is the aim of the upgrade programme for the instrument HEiDi. The group of the RWTH Aachen operating the instrument plans to optimise the neutron monochromatisation with Cu220 crystals and a focussing neutron guide. This development will support the application of single crystal neutron diffraction with hydrostatic pressure up to 10 GPa at the MLZ. Special developments for corresponding high pressure diamond anvil cells are as well part of the project. The scientific impact will be on a wide range of research topics including multiferroics, magnetocalorics, superconductors and framework structures. The implementation of a highly sensitive 2d detector for wavelength $\lambda < 1 \text{ \AA}$ will increase the instrument's performance in order to avoid ambiguous structure determination and enable fast and reliable characterisation of samples and structures in view of grain distributions and superstructures. At the same time it will speed up the overview of sample reflections at the start of an experiment.

MIEZETOP is the title of the project to develop a modular, transportable turnkey set-up for quasi-elastic, high resolution neutron measurements. For many years the group of Peter Böni at the Physics Department of the Technical University of Munich, operating the instrument **MIRA** had developed spin-echo techniques especially resonance techniques with the MIEZE option. Here the spin modulation is performed before the sample position and a time modulated signal is recorded after the sample scattering in the detector. By this, experiments with the spin-echo technique are possible using strong magnetic fields at the sample position. Recent developments at the instrument RESEDA laid the basics for the MIEZETOP project to design a **Longitudinal Neutron Spin Echo (LNRSE)** add-on with a total length of 1 m for measurements in magnetic fields and ferromagnetic materials using MIEZE. The

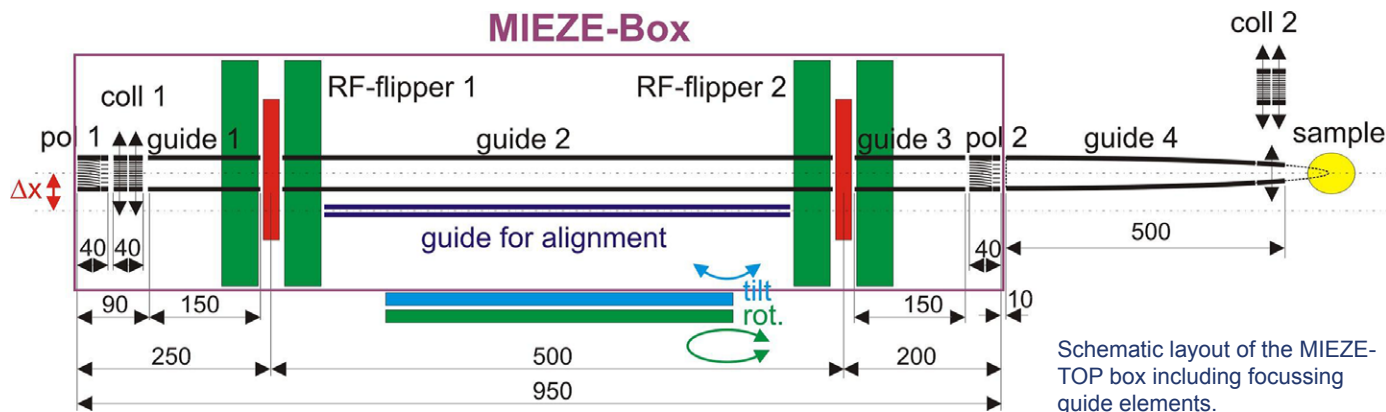

achievable total field integral will yield spin echo times of 10 ns using 10 Å neutrons at the instrument MIRA. A gain in the neutron flux to investigate small samples will be achieved by the integration of focussing guides in the MIEZETOP device. The goal is to develop a transportable and easy-to-use set-up which might be used for measurements even at the 26 T magnet at the HZB in Berlin.

The second project using the LNRSE technique is targeted to boost the performance of the **RESEDA** spectrometer: RESEDA-Plus. The group of Christian Pfleiderer at the Physics Department of the Technical University of Munich is going to develop a longitudinal NRSE set-up with extreme resolution. Increasing the NRSE spin-flip frequency up to 5 MHz a field integral in the order of 700 nTm would be obtained leading to spin-echo times of 920 ns using neutrons with a wavelength of 20 Å. These extreme parameters demonstrate what might be possible for highest energy resolution using neutrons. Combining the LNRSE set-up with focussing neutron guides addresses one of the major drawbacks for high resolution spectroscopy: flux.

Extending the application of a three axes spectrometer to map inelastic scattering over a large momentum and energy transfer range is the aim of the BAMBUS project by the institute of solid state physics at the TU Dresden. A multiplexed analyser option for the instrument **PANDA** using cold neutron will be developed, which can be changed in short time replacing the conventional analyser-detector arms. The optimisation for the PANDA spectrometer will match properties of the primary spectrometer for high flux and reso-

lution. The multi-analyser system with record neutrons at multiple scattering angles and five different energy transfers. Special care will be taken to maintain the high energy resolution and the low background in the order of 1 count per minute of the PANDA spectrometer. The scientific systems of interest cover quantum and low dimensional magnetism often featuring distributed scattering intensities in Q-space. It will meet the demand for low mass or small magnetic moment samples by using the large monochromatic flux at the sample position which is in the order of 100 times higher compared to existing spallation sources. The BAMBUS project will enable parametric studies on apply field or pressure as the design of the TAS exhibits only few geometry limitations compared to most TOF instruments.

Better positrons

POSITEC: improving the instrumentation for the high flux, high brilliance positron source **NEPOMUC** at the MLZ was the headline for six different sub-projects out of which five received funding in the current period. They cover developments to improve the source parameters as well as implementing and extending the usage at the attached measuring stations. The projects will be realised at the Institute for Applied Physics and Metrology at the Universität der Bundeswehr München and Physics Department of the Technical University of Munich operating jointly the NEPOMUC facility.

A key component of the entire NEPOMUC facility is the moderator of the positron beam as it defines the energy distribution of the particles and by this the bril-

liance of the beam. A first moderation takes place during the pair conversion process in the tip of the beam nose, a second remoderation outside the reactor shielding is necessary to improve the beam quality to the required parameters for the positron instruments, especially where the beam is focussed to small spot sizes. The development of a new remoderator aims to enhance the brightness of the positron beam by a factor of 1000 which substantially increases the performance of existing instruments and makes entire new applications possible. One example will be the installation of a **Scanning Positron Microscope (SPM)**. It will focus down the positron beam to a size at the sample position of 1 μm enabling a pulsed positron beam for defect microscopy. The improved brilliance of the positron beam will boost as well the **Pulsed Low Energy Positron System PLEPS** in view of a better time resolution in lifetime spectroscopy. It will provide higher count rates and by this higher throughput to serve much more users with beam time.

Improvements of the **Coincidence Doppler Broadening Spectroscopy (CDBS)** aims to perform ultrafast CDBS and position sensitive defect analysis with a

continuous beam using diameters in the range from 10 to 100 μm . These developments will allow in situ experiments under load using a special pulling device at the CDBS beam line. An entire new application will apply positron diffraction under total reflection of the beam. Here the inherent surface sensitivity of the positrons will be used to analyse the structure of the top-most surface layer of a sample.

Sample environment

Compiling its scientific roadmap, the MLZ has identified an increasing demand for in-situ experiments with neutrons where the sample material under investigation is exposed either under extreme conditions like stress, temperature, or magnetic field or is triggered to undergo a well-defined transition or transformation in order to investigate the kinetic of this process. The simultaneous usage of complementary measurements like light scattering or NMR enables further insight into the process, controls the applied sample parameters, and relates the neutron experiments more precisely to complementary experiments in the laboratory.

NEPOMUC at MLZ
© W. Schürmann (TUM)

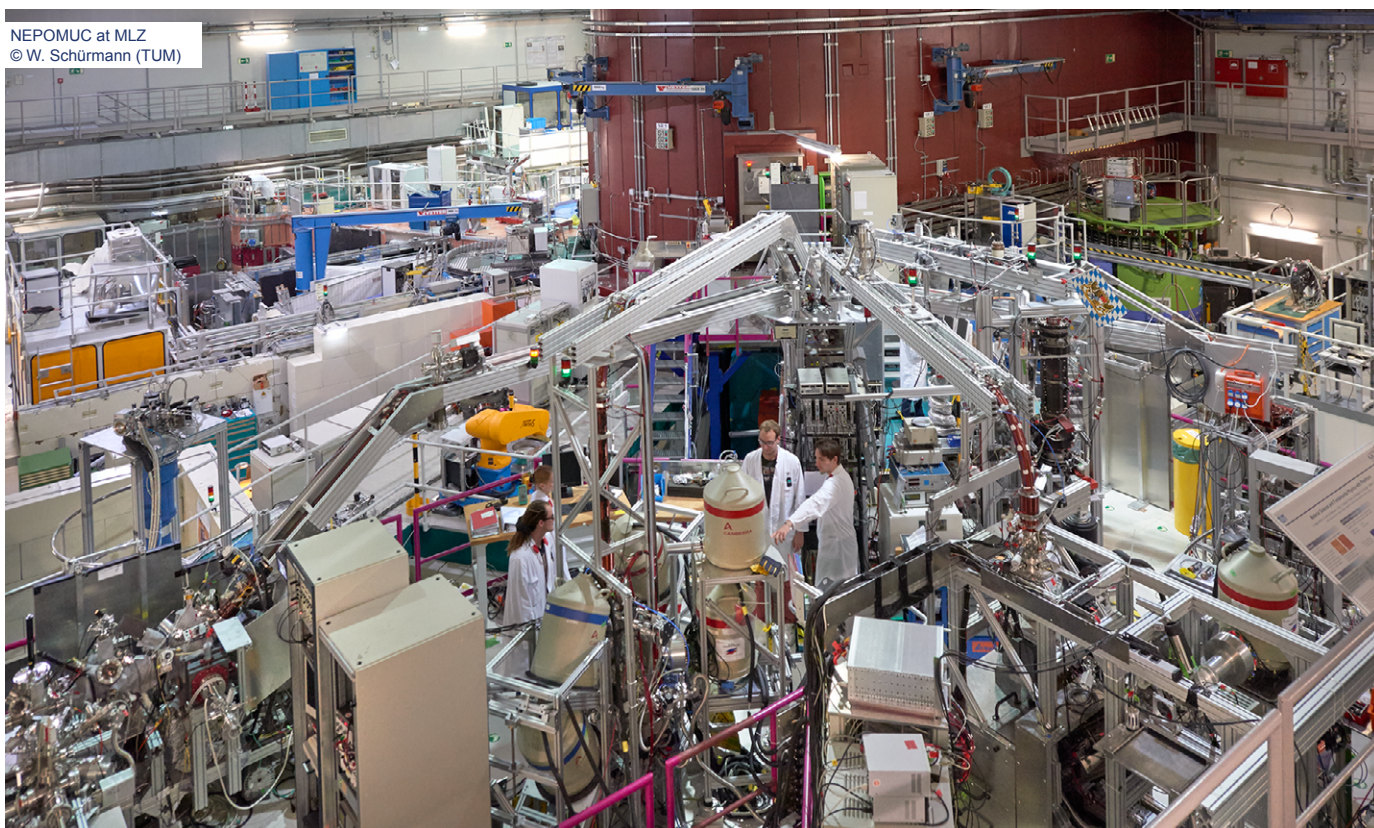

The project by the Institute for Functional Materials at the Physics Department of the Technical University of Munich will set-up a new sample environment for Laser-Pump-QENS-Probe experiments at the time-of-flight spectrometer TOFTOF. The goal is to investigate strong correlations between the functionality and dynamics in biological samples, so far probed by QENS in the stationary state. The new set-up will extend the capabilities of TOFTOF to in-operando studies of cyclic, light induced physiological processes, e.g. studies of the photo cycle in Bacteriorhodopsin (BR) or the light absorption in photo system II. Within the scope of the project a Laser-Pump set-up and a Raman spectrometer will be installed and integrated into the TOFTOF spectrometer. It covers the optical path integration, the implementation of timing signals for Laser and data acquisition as well as the adaptation of data acquisition for time resolved measurements.

To enable following the precipitation kinetics during the complete thermomechanical process chain in a Ni-base super-alloy or performing in-situ experiments related to the forging process applied in industry, a new test rig will be developed at the MLZ. The project aims to provide a unique sample environment for basic research and applied studies for industrial requests in the field of materials science. The new test rig will apply loads of up to 100 kN and implement a vacuum furnace to reach sample temperatures up to 1100°C simultaneously. The integration of a fast and controlled cooling device for precipitation studies will extend the in-situ parameters to mimic industrial production processes. This new device will be available on diffraction and small angle scattering instruments at the MLZ.

Combining neutron scattering with complementary techniques in the field of life science is the objective of a new project jointly carried out by the Institute of Physics at the RWTH Aachen University and the JCNS of the Forschungszentrum Jülich. A special focus is laid on the combination of **D**ynamical **L**ight **S**cattering (DLS) and quasi-elastic neutron scattering in order to achieve a quantitative biospectroscopy for example to study the complex folding of proteins. The developments will include the creation of standard experimental procedures and data analysis to support new and less experienced user groups.

Software development

Bridging the application of complex in-situ sample environment to a detailed analysis at the new time-of-flight diffractometer PowTex, actually under construction at the MLZ, is the aim of a project of the Geowissenschaftliches Zentrum of Georg-August-Universität Göttingen. Performing parametric investigations on phase diagrams and transitions or measuring time resolved in-situ kinetic reactions require dedicated software tools for the online visualisation ensuring an optimised beam time usage. The complex geometry of the time-of-flight neutron detectors at PowTex on one hand and new time-resolved tri-axial in-situ deformation experiments on the other hand need specialised software tools for the texture analysis of the high resolution data. A special focus of the investigations will be in the area of geoscience.

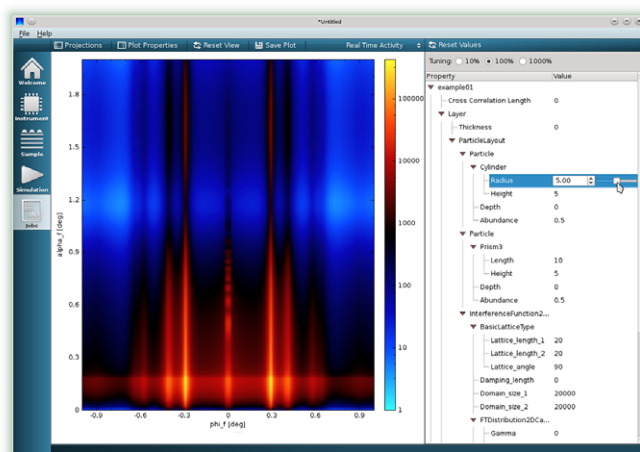

BornAgain Graphical User Interface: Real Time View.

In order to get new insight in 3-dimensional heterogeneous thin films or layer structures small angle scattering at grazing incident angles can be used. To understand and analyse the complex scattering pattern of GISANS or GISAXS experiments the software package BornAgain (www.bornagainproject.org) shall be extended by a group at the Friedrich-Alexander Universität Erlangen-Nürnberg in close collaboration with the MLZ Scientific Computing Group. Neutron experiments on artificial well defined reference samples are planned of test the new routines and models to be implemented in the BornAgain software.

J. Neuhaus (FRM II)

Evolutional upgrade of KWS-3

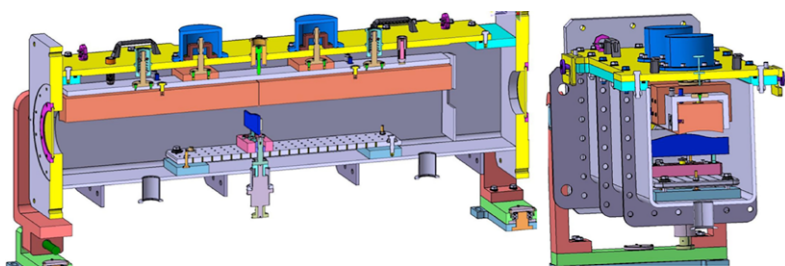

Fig. 1: New compact mirror chamber (above); it is ready for transfer of the mirror (right).

KWS-3 is a **very** small angle neutron scattering diffractometer operated by JCNS. The principle of this instrument is one-to-one imaging of an entrance aperture onto a 2D position sensitive detector by neutron reflection from a double-focussing toroidal mirror. KWS-3 can be used for the analysis of structures between 30 nm and 20 μm .

In 2016 several “evolutional” projects on the KWS-3 instrument have been almost finalised: new compact mirror chamber; new mirror positioning/ focussing system; new design of the main sample station; new platform of the main sample station.

The first two projects were initially planned as a single project. Several important questions were solved by the new design of the mirror chamber and positioning system:

- minimisation of the mirror chamber size;
- efficient decoupling of the focussing system from the other parts of the instrument without losing initial functionality;
- integration of the “easy-focussing-of-mirror” construction with the possibility to focus the mirror remotely;
- integration of new beam “definition” system. Two motorised apertures (with mirror profile blades) before and after the mirror, in combination with a 1-blade aperture (also with mirror profile) in the middle of the mirror allowing only the neutrons reflected from the mirror to pass in sample’s direction.

The compact design of the mirror chamber is shown in fig. 1. The mirror is fixed to the covering plate of the chamber, simplifying fixation of the mirror in the mirror chamber. The focussing of the mir-

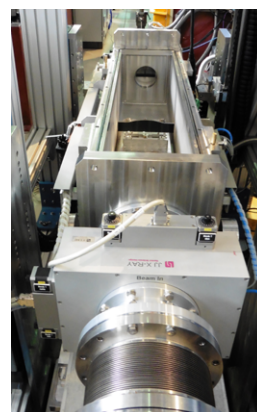

ror is achieved by adjustment of the mirror chamber.

The mirror chamber is connected to the mirror positioning system as shown in fig. 2. The positioning system has three motorised axes: vertical hub system with translational range of ± 50 cm, mirror tilting hub ± 10 cm, and horizontal translational table ± 8 cm. All axes have absolute length encoders with precisions better than 1 μm . The mirror chamber is connected to the positioning system with three degrees of freedom to be always “in focus” by x-translation.

In the new design of the instrument we integrated a hub table with a travel range of more than 70 cm and a maximal load of 1000 kg. A 3D model of the new construction of the sample station just after the mirror is shown in fig. 2. The bulky sample environment could be installed after removing the sample chamber. Medium-sized sample environment can be installed between the sample and mirror chambers.

V. Pipich (JCNS)

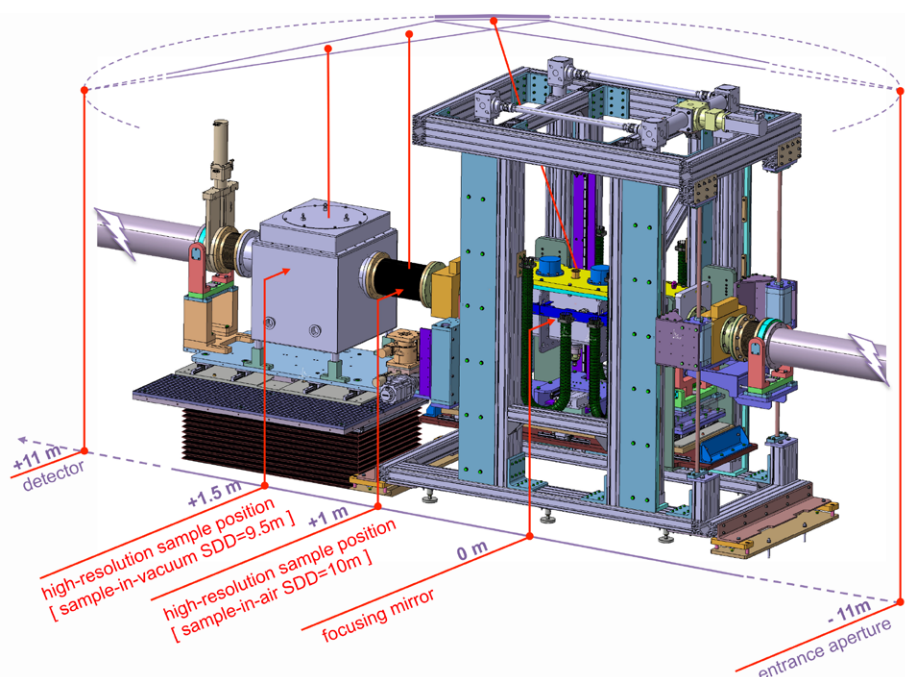

Fig. 2: New design of the main sample station and the positioning system: 3D model with explanations.

New set-up at PGAA

To enable a larger variety of experiments at the **Prompt Gamma Activation Analysis (PGAA)** facility in the Neutron Guide Hall West, we decided to build a new, more flexible instrument.

Besides the old HPGe detector with the relative efficiency of 60%, we installed a LEGe (low-energy germanium) detector. The detector has a reasonable counting efficiency for low-energy gamma rays only, i.e. up to 1 MeV and at the same time, its resolution is significantly better than that of the large-volume detectors. According to the plan, this detector will be surrounded by a Compton suppressor scintillator annulus to lower the spectral base line.

The neutronic part of the instrument remained the same: a pneumatic system (now software controlled) interchanges between a collimator and a focussing neutron guide to switch between medium and high fluxes. A rapidly removable lead wall separates the sample chamber from the neutron guide to lower the radiation background.

The new sample changer consists of a drum accommodating 16 aluminum frames in a carousel, from where a pneumatic system pushes the sample into the irradiation position. The whole tube can be evacuated and also rotated around the centre allowing for the irradiation or the counting under optimum angle. The sample tube can be replaced with a bell-shaped sample holder cap for the measurement of large single samples.

The two detector shieldings, the additional walls with changeable gamma collimators in front of the detectors, and the beam stop can be moved on a rail system. The new instrument can now be rapidly modified for different applications, like standard prompt gamma

activation analysis, gamma-gamma coincidence counting in nuclear physics measurements, neutron radiography, prompt gamma activation imaging, or neutron depth profiling.

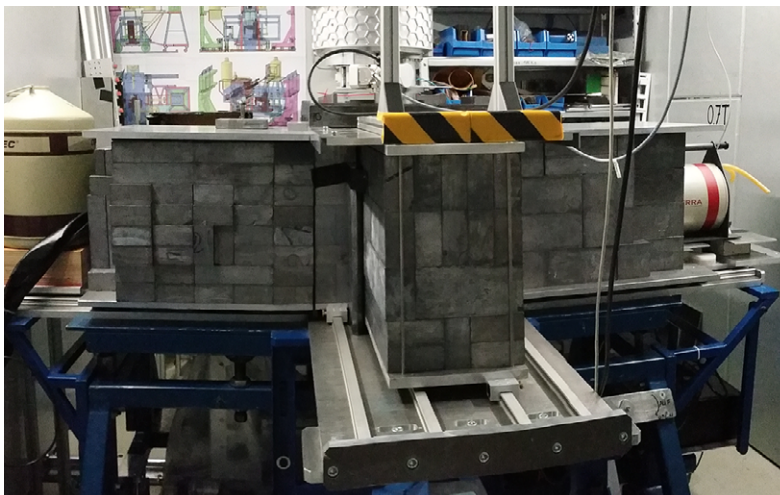

The complete shielding with sample changer.

The software control of the neutron irradiation and the gamma-ray counting has now been unified in a single program in a user-friendly way, and is compatible with the control system at MLZ. One can choose between the high and the medium fluxes, together with the different attenuators, thus the beam flux can be changed from

2×10^7 to about $4 \times 10^{10} \text{ cm}^{-2} \text{ s}^{-1}$. The sample changer and the spectrum acquisition are also controlled by the software, and it makes possible to run long batches with different measurement conditions. A log-file is continuously recorded which can now be easily loaded into the electronic logbook.

The design of the sample chamber and the rail system for the movable detector shielding.

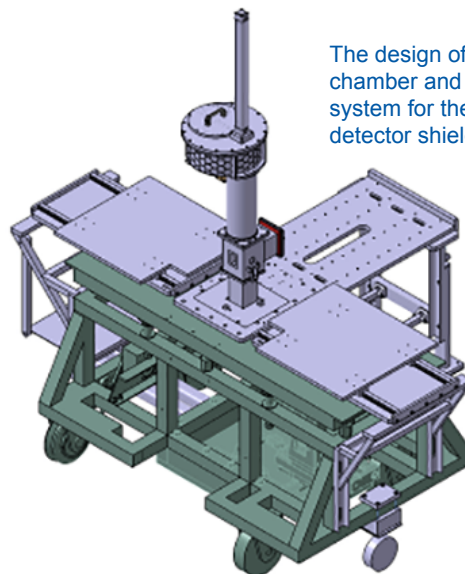

The new set-up has proven to serve the different experiments at PGAA properly during the cycles in 2016.

Z. Revay, P. Kudejová, Ch. Stieghorst (FRM II);
S. Thiel (Universität zu Köln);
J. Schwarz (Hochschule München)

Magnetic field at TOFTOF

The HTS magnet, providing fields up to 2.2 T, went into the user programme of MLZ in the beginning of 2015. Maybe you have already seen the device and asked yourself, why its shape is so peculiar, with cable connections and the cooling tower to one side, and the asymmetric openings of the room temperature bores?!

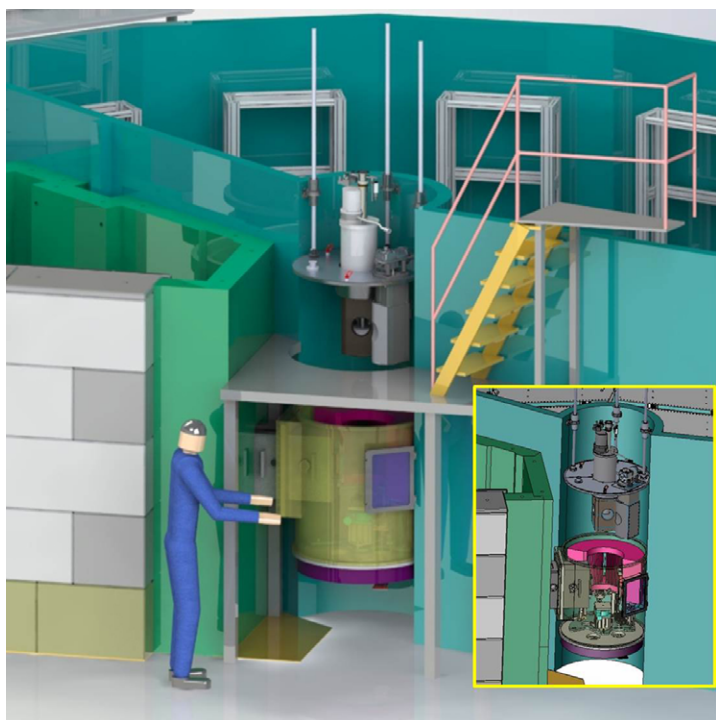

Schematic drawing of TOFTOF.

The reason for this was the intention to design and build a magnet that can also be used at TOFTOF. So far, measurements at the cold time-of-flight spectrometer were restricted to be at zero magnetic field, thus limiting the experimental capabilities of the instrument. The challenges to have a magnet at TOFTOF were twofold: first of all, the angular coverage for the detectors should not be restricted too much, and second, the dimensions of the magnet should be such that it could fit into the TOFTOF sample chamber, notoriously known for its restricted space. The former could

be archived by joining two perpendicular 30 deg openings giving an effective viewing field of 120 deg (although part of it is in the forward direction not probed at TOFTOF). The spatial restriction required some careful design work, and before production, even a mock up was provided by the company to verify the final dimensions directly at the instrument. When the HTS-magnet is now installed at the instrument, there are only a few millimetres to spare to the guide housing at the front, and the beam stop as well as the radial collimator at the rear. A dedicated mounting flange and positioning system was developed in-house, which enables a fast and reliable installation (and subsequent removal) of the HTS magnet into the sample chamber during user operation. At the left you see a schematic drawing of the mounting flange (including the magnet) with the guiding rods used for positioning. The room temperature bore of the magnet accepts a standard CCR cryostat, and if needed, a ^3He or dilution insert can be used as required. During measurement, special attention has to be paid to potential sources of background due to the smaller cryostat tail compared with the standard TOFTOF cryostat. The field is oriented in the vertical direction and the useful angular detector coverage extends to 105 deg (in comparison to 140 deg the standard TOFTOF configuration).

With the new HTS magnet, we now have – for the first time – a (vertical) magnetic field up to 2.2 T available for measurements at TOFTOF. The first external user experiment was scheduled and performed in summer

2016, measuring excitations in a molecular magnet. The lower figure shows a glance at the data. With the first successful measurement, we welcome proposals for TOFTOF requesting magnetic fields.

W. Lohstroh (FRM II)

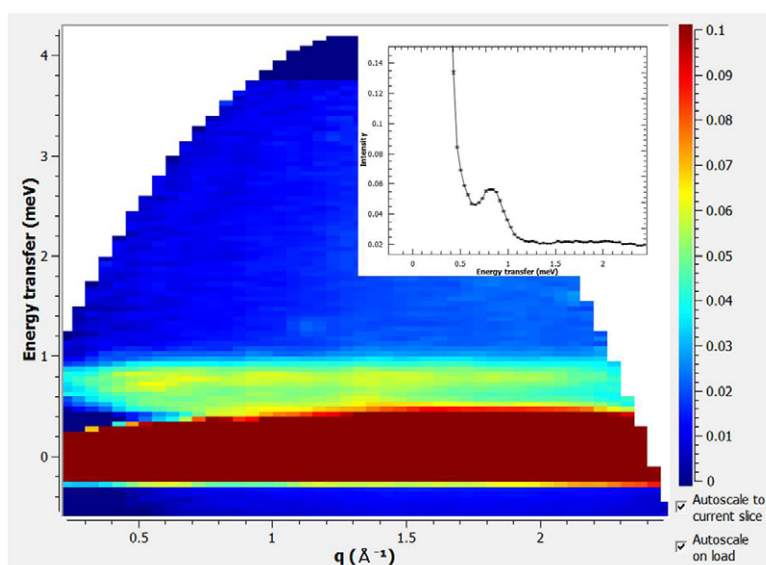

First example!

Neutrons For Energy

In July 2016, energy researchers from all around the world came to the MLZ conference *Neutrons For Energy* in Bad Reichenhall to discuss current results and questions from various areas of energy research with neutrons.

A broad variety of topics, ranging not only from batteries to fuel cells, from solar cells to catalysts but also from new high-temperature materials to thermoelectric and magnetocaloric materials. The unique properties of neutrons, e.g. their capability in observing light elements such as lithium and hydrogen and following their motion make them an indispensable tool in energy applications. In situ and operando measurements were one of the hot topics, where e.g. spatially resolved diffraction of batteries during charging and discharging or radiography of the water

distribution in fuel cells during operation had been investigated.

Initiating and reinforcing collaborations between neutron scattering institutions and the energy research community was the aim of this conference. More than 90 participants were an impressive proof for the potential of using neutrons for energy research.

O. Holderer (JCNS)



More than 120 participants attended PNCMI 2016

The 11. *International Conference on Polarised Neutrons for Condensed Matter Investigations 2016*, (PNCMI 2016), was attended by more than 120 participants from all over the world. The conference took place in the conference centre at the Freising Domberg (cathedral hill) on July 4th-7th, 2016. The scientific focus of the meeting touched on the latest condensed-matter investigations using polarised neutrons as well as state-of-the-art methodologies and techniques of polarised-neutron production and utilisation for novel instrumentation and experiments. Special emphasis was placed on prospects for new science and new instrument concepts. 22 invited and more than 30 contributed oral

presentations together with two large poster sessions reflected the active and broad engagement on the topic also with many presentations by MLZ members on this occasion.

The conference was organised by the Jülich Centre for Neutron Science (JCNS). Financial support was gratefully received from Forschungszentrum Jülich, the Research Neutron Source Heinz Maier-Leibnitz (FRM II), ISIS, Laboratoire Léon Brillouin (LLB), the Paul Scherrer Institute (PSI), SwissNeutronics AG, the

Japan Proton Accelerator Research Complex (J-PARC), Mirrotron Ltd., and Airbus Defence and Space S.A.S.

T. Gutberlet (JCNS)



Celebrating 50 years of neutron backscattering

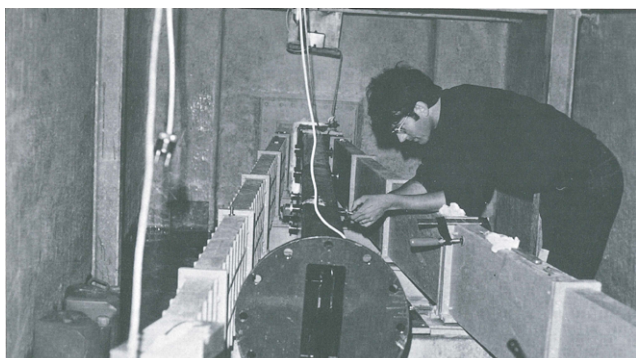

Anton Heidemann: A picture from the early years working at the instrument (left) and in September 2016, cutting the workshop's special motive torte (right).



Heinz Maier-Leibnitz, the patron of our MLZ, generated ideas for neutron instrumentation by geometric thinking in wavevector space. In 1966, he explained these concepts in a paper entitled *Grundlagen für die Beurteilung von Intensitäts- und Genauigkeitsfragen bei Neutronenstreuungsmessungen* [Nukleonik 8, 61]. As one consequence, he pointed out that the energy resolution of a three axes spectrometer could be improved by orders of magnitude if the Bragg angles of the monochromator and analyzer crystals were sent to 90° . Of course, this backscattering geometry would entail some difficulties: How to separate the reflected from the incoming beam? How to modulate the energy, if not by variation of the Bragg angle? And how to obtain practicable intensities in spite of the strong energy selection?

Later in 1966, a young Diplom-Physiker, Anton Heidemann, came back from a six-month trip to Nepal, searched for a PhD topic, and opted for neutron backscattering. Since this was a big and difficult project, he was allowed to bring in his friend Manfred Birr. The twins, as they soon were called, would build an instrument together; then each of them would use it for a physical measurement of his own. So 1966 became the starting year for the development of the backscattering spectrometer, an instrument type that nowadays can be found at all major neutron facilities.

To celebrate this jubilee, Victoria Garcia-Sakai (ISIS), Bernhard Frick (ILL), Thomas Brückel (JCNS) and Winfried Petry (FRM II) organised a workshop *50 Years of Neutron Backscattering* in Garching on September 2nd and 3rd, 2016. Anton Heidemann and Manfred Birr attended as honour guests. Heidemann told the story of backscattering from the Garching prototype via the first permanent instrument PI at Jülich to

IN10, for decades a workhorse at the ILL. Other former and present instrument responsables continued the tale, explaining phase-space transform choppers and other ideas that enabled the construction of modern spectrometers with much higher count rates. This retrospective part of the workshop also had moving moments when the memory of dear colleagues who had passed away in recent years was evoked: Bertold Alefeld, Michael Prager, and Philip Tregenna-Piggott.

In the second part of workshop, current uses of backscattering spectroscopy were presented. They range from fundamental quantum-mechanical problems in simple molecular systems, addressed by rotational tunneling, to applied research like the in-operando investigation of fuel cells. Compared with spin echo, backscattering is particularly suited for the investigation of incoherent scatters. Therefore, many of the applications are concerned with hydrogen-rich materials like confined water, polymers, proteins, membranes. Most impressed by these developments was Manfred Birr, who at the end of his PhD work had measured the first backscattering spectrum of glycerol.

The workshop was also attended by an artist: Rob Dimeo, former backscattering instrument responsible and now director of the NIST Center for Neutron Research, had not only prepared his own talk in form of sketchnotes, but also drew two more sketchnotes to summarise the talks at the workshop and the history of backscattering. These drawings will appear in the *Journal of Neutron Research* and we are grateful to Rob and to the journal for the kind permission to reproduce one of them on the following page.

J. Wuttke (JCNS)

THE BACKSCATTERING STORY

A PERSONAL VIEW
ANTON HEIDEMANN

MUNICH
1965-1970

1966 DIPLOMA
A. HEIDEMANN

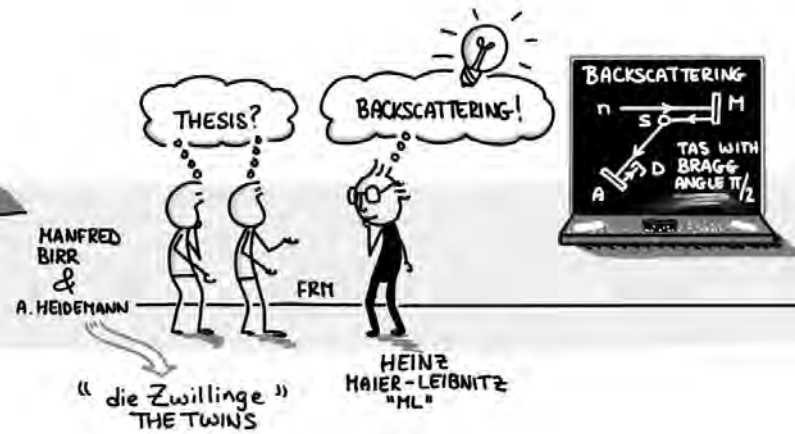

CHALLENGES

- 1 LOW INTENSITY → ANALYZER WITH LARGE SOLID ANGLE?
- 2 HOW TO SEPARATE INCIDENT AND REFLECTED BEAM?
- 3 HOW TO VARY THE ENERGY?

1970
BSS DISMANTLED



FIRST MEASUREMENTS
V SPECTRUM - 10 DAYS
S:N ~ 1
RES ~ 0.6 μ eV
As₂O₃ - COULDN'T SEE ELASTIC PEAK - WHY?
V₂O₃ - INELASTIC SPIN FLIP SCATTERING

BSS INSTRUMENT FRM

ANALYZER
2000 Si XTALS
ALIGNED TO <0.1°
ON A CURVED SUPPORT



GOOD RELATIONS WITH THE MECHANICAL WORKSHOP!

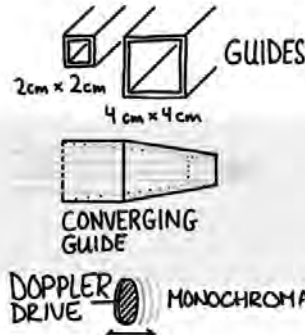

1964 DOUBLE X-TAL VERTICAL NEAR BACKSCATTERING GEOMETRY

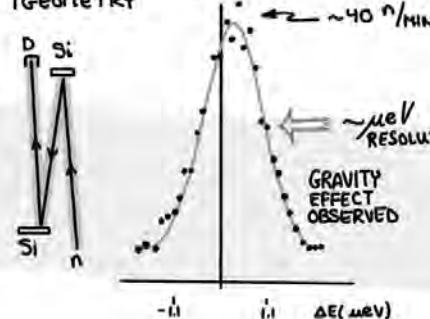

BACKSCATTERING DIFFRACTOMETER WITH MÖSSBAUER DRIVE
MEASURE LATTICE PARAMETER CHANGES IN SrTiO₃ NEAR PHASE TRANSITION

JÜLICH
1970-1972

COMMISSIONED PI-SPECTROMETER
TRANSPARENT DOPPLER DRIVE
100x FLUX OF MUNICH BSS
PG XTAL DEFLECTOR
MULTI ARM ANALYZER



CRYSTAT FIXED V₂O₃ MEASURED WITH POLISHED Si XTALS
→ 0.3 μ eV RESOLUTION!
MORE SUCCESSFUL V₂O₃ MEASUREMENTS

NEW RESEARCH
SELF-DIFFUSION IN Na SINGLE X-TAL
H MOTIONS IN N DOPED Ni
NH₄ REDORIENTATIONS IN NH₄Cl
TUNNELING OF CH₃ GROUPS

GRENOBLE & ELSEWHERE
1971 - 2014



AS LONG AS IT'S CHEAP AND JÜLICH PROVIDES THE DOPPLER DRIVE AND A PDP-11 COMPUTER

USING THE PDP-11 WAS A NIGHTMARE!

IN10 BUILT IN 2 YEARS
1974 - COMMISSIONED

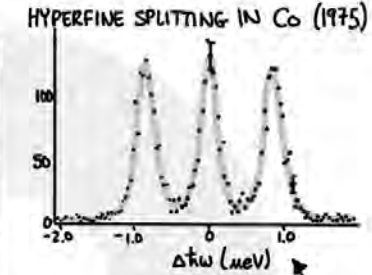
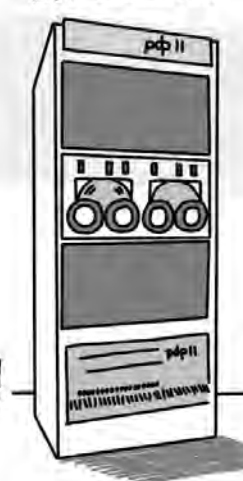

MÖSSBAUER WAS IMPRESSED!



THE → GHz
... OFFERING NEW OPPORTUNITIES IN NEUTRON SPECTROSCOPY

THE DEVELOPMENT OF A NEW METHOD, WHENEVER ITS PRECISION, SENSITIVITY OR RESOLUTION IS MUCH BETTER THAN EVERYTHING THAT EXISTED IN THIS FIELD BEFORE, CREATES NEW PHYSICS

- MAIER-LEIBNITZ

MORE BACKSCATTERING

- IN10 B - TEMP SCANNING MONOCHROMATOR
- IN13 - THERMAL NEUTRON BACKSCATTERING
- IN16 - HIGH PERF BACKSCATTERING
- NIST HFBS - WITH FIRST PHASE-SPACE TRANSFORM CHOPPER (PST)
- IN16B - PERF UPGRADE INCL/PST
- FRM II SPHERES - HIGH PERF BACKSCATTERING W/PST
- IRIS, OSIRIS (ISIS), BASIS (SNS), BLOZ DNA (J-PARC)
- EMU (ANSTO)

SCIENCE ON IN10

1ST USER EXPERIMENT

POLYMER DYNAMICS - JULIA HIGGINS AND THE OCCASIONAL EVENT - WATER LEAK FROM MAGNET DURING LIQUID CRYSTAL EXPT.



SEARCH FOR NUCLEAR SPIN WAVES

LIQUID CRYSTALS

TUNNELING

CH₄

CH₃-GROUPS

HYPERFINE INTERACTIONS

SKETCHNOTE: R. DIMEO SEPT. 02, 2016

Local events with the MLZ



On September 10th and 11th, the *Garching Autumn Days* took place, a regional trade fair. Since the FRM II is an important institution in Garching and therefore a well-liked exhibitor. The sum total this year: 85 exhibitors, 30 degrees heat, and the largest part of Garching's residents in the centre in the shade. In this weather, little less visitors than usual found the way to the booth in the city hall. However, they had many questions and enjoyed the fact that they could ask them all.

Quite different at the *Open Day* on October 22nd on the Garching campus: Significantly more than 10,000 visitors



came at pleasant temperatures and bright sunshine. Thanks to tighter planning and dedicated staff, more visitors than usual could visit the research neutron source, namely 557. The demand was, however, considerably higher and can obviously never be fully satisfied. But those who went away empty-handed, were not disappointed as the Physics Department offered a whole bunch of other highlights such as FRM II and its radiation protection's info desks, physics games, impressive labs, astonishing experiments, interesting and well-attended lectures and short films. The booth of the MLZ was constantly crowded around. For the first time, the positron source was presented with its own info desk to explain to interested visitors how these exotic particles are produced with the help of neutrons and what the scientists can do with them. Some 130 visitors filled out a questionnaire – many with enthusiastic commentaries such as “we are overwhelmed” and “keep it up!”. This is our order for October 2017 when all laboratories and facilities are opening their doors again.

A. Voit (FRM II)

Happy visitors as well as winners of the really cool and limited shirts at the Garching Autumn Days (both photos above) and at the Open Day (three lower photos).

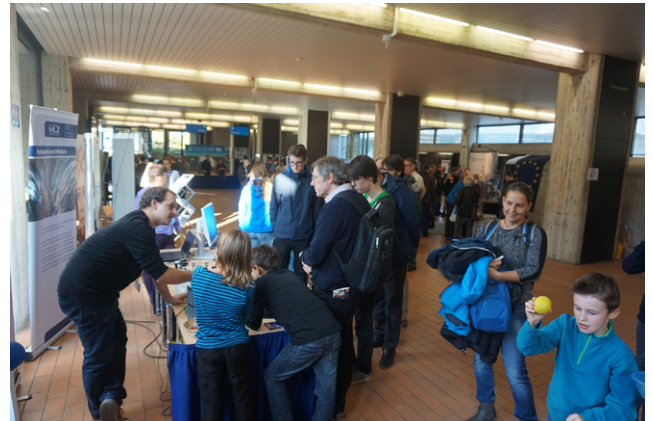

German neutron scattering community gathered at Kiel

The world's sailing capital Kiel hosted the *German Conference on Neutron Scattering* in the end of September. From the 20th on, more than 200 researchers doing experiments with neutrons met for three days of inspiring talks and fruitful discussions. As an addition to the well-balanced main programme, four mini-symposia focussed on different topics were held:

- Proteins: Dynamics and interactions
- High brilliance compact neutron sources - status and perspectives
- Neutron spectroscopy for dynamics in confinement
- Materials characterisation

Furthermore, a CREMLIN workshop on German-Russian cooperation took place after the conference.

A highlight was the conference dinner: Cruising the Kieler Foerde with a glass of wine and excellent food by night was really a gorgeous experience!

The MLZ User Office had organised a booth as usual and was not only happy to meet so many old and new users but also to be under the first ones congratulating our colleague honoured with the Wolfram-Prandl-Prize ([read more on p. 25!](#))

All participants will remember the beautiful lamps at Kiel's Audimax building – is there anybody who did not try to take a nice picture of it??

I. Lommatzsch (FRM II)



Workshop on SoNDe Application in Neutron Detection at Freising



On October 17th–19th, a workshop for scientific and industrial participants dealt with the potential of the SoNDe detector technology in their various fields. The SoNDe projects aims to develop a prototype for a neutron detector with the following specifications:

- High-flux capability, capable of handling the peak-flux of up-to-date spallation sources (gain factor of 20 over current detectors)
- High-resolution of 3 mm by single-pixel technique, below by interpolation
- High detection efficiency of 80% or more

- No beam stop necessary, thus enabling investigations with direct beam intensity
- Strategic independence from ³He
- Time-of-flight capability
- Modularity for ease of maintenance

Several presentations addressed the overview and scope of the project, applications in research, safety, and industry as well as benefits compared to other neutron detector technologies.

Finalising the workshop, all participants were collecting ideas, proposals, and requests of needed support from the SoNDe project in a constructive open discussion session, later to be published as conference proceedings.

We want to thank the EU (H2020 Grant No. 654124) and Hamamatsu Photonics for financial support. www.fz-juelich.de/ics/ics-1/DE/Leistungen/ESS/SoNDe-Projekt/_node.html

S. Jaksch (JCNS)

6th VDI-TUM Experts Forum: Focus on high performance materials

The VDI-TUM Experts Forum, which is organised at intervals of two years by the VDI and the MLZ, took place at the Campus Garching on September 15th. As always, it was fully booked and the organisers of the Committee *Application-oriented non-destructive material and component testing* were again able to offer a whole range of exciting talks. This time the focus was on high-performance materials and their non-destructive testing.

Besides enormous applications and operation scenarios, high-performance materials and technologies also come up with great challenges and high demands on the non-destructive testing. The numerous short talks devoted to the question how both can be used – es-



established testing techniques such as ultrasound, thermography, tomography and residual stress analysis as well as new, still in the development process as the 3D terahertz imaging or analysis

by neutron scattering methods. Composite materials, special alloys and exotic metal forming for airplanes, medical products and many other applications were the subjects to be talked about. Many of these materials and also the corresponding testing methods are developed to reduce costs in material and service. Completed were the numerous talks of industrial users by some results of recent research, e.g. of lithiation/ delithiation in Li-ion batteries or strain determination in railway tracks.

R. Gilles, C. Kortenbruck (FRM II)

First BornAgain School gave input for further development



Grazing-incidence small-angle scattering (GISAS) is a powerful technique for studying nanostructures near surfaces. The feature-rich detector images contain contributions from reflected and refracted rays that

must be disentangled with the help of computer simulations, based on parametric sample models. For this purpose, the MLZ Scientific Computing Group is developing a new software, called BornAgain (alluding to a standard approximation named after Max Born).

In November, the authors of BornAgain presented their software at a GISAS workshop at DESY, and then invited to a satellite meeting in Garching: the First BornAgain School and User Meeting. Thirty-two neutron and X-ray users from research groups in five countries attended two intense days of lectures, hands-on training, and discussions. Their enthusiastic feedback provided valuable guidance for the future development of BornAgain.

J. Wuttke (JCNS)

First Joint Workshop JCNS and Flipper: In-depth exchange between scientists of related neutron communities

The first *Joint Workshop JCNS and Flipper 2016 – Modern Trends in Neutron Scattering for Magnetic Systems/ Single-crystal Diffraction with Polarized Neutrons* was held at the Evangelische Akademie Tutzing on Lake Starnberg, south of Munich from October 3rd –7th, 2016. Flipper, the workshop for single-crystal diffraction with polarised neutrons, had previously been organised by the Institut Laue-Langevin in Grenoble in 2010 and 2013.

Sixty participants from Europe, Russia, Taiwan, and Japan attended the combined workshop. Forty invited and contributed talks were given and eight posters were presented. Topics included unconventional superconductors, functional materials such as multiferroics and magnetocalorics, quantum and frustrated spin systems, nanomagnetism and neutron methods and instrumentation focused in particular on the use of polarized neutrons for magnetism. Neutron scattering provides the basis for a fundamental understanding of the structure of the materials related to the different topics under discussion at the workshop. An afternoon excursion to the weather observatory on Hoher



Peissenberg in the Alpine Foreland along with the workshop dinner offered time for further discussions and deepened the scientific exchange between participants. Financial support from Oxford Instruments is gratefully acknowledged.

Save the date:

The JCNS Workshop 2017 will focus on neutron instrumentation and will be held in Tutzing from October 10th–13th, 2017!

Y.Su, V. Hutanu, R. Bruchhaus (JCNS)

20th JCNS Laboratory Course Neutron Scattering

The 20th *JCNS Laboratory Course Neutron Scattering* took place at Forschungszentrum Jülich and Heinz Maier-Leibnitz Zentrum (MLZ) on Sept. 5th–16th, 2016.



The labcourse is open to students world-wide of physics, chemistry, and other natural sciences. The course is part of the curriculum of RWTH Aachen University. Starting this year, students can earn **European Credit Transfer System (ECTS)** points by taking an optional examination. Participation in the course is free of charge. Forschungszentrum Jülich financed the course with

support from the EU projects SINE2020 and Soft-Comp.

As in the years before, the course was divided into a week of lectures and exercises in Jülich and a week of practical training at eleven instruments at MLZ. These world-class instruments were provided by Jülich Centre for Neutron Science (JCNS), TUM, RWTH Aachen, University Göttingen, and KIT.

This year, 54 students were selected from 185 applicants. 20 foreign students came from a total of 13 countries. As always for this course, the participation of female students was high, this year 48%.

The next JCNS laboratory course will take place Sept. 4th–15th, 2017. You are invited to submit applications at www.neutronlab.de (open from January 2017).

Reiner Zorn (Forschungszentrum Jülich)

Joining forces for neutron imaging: The Neutron Imaging Group at MLZ

The neutron imaging expertise at MLZ has recently been combined in a newly established Neutron Imaging Group. The objective of the group's installation is to foster exchange between the individual instrument teams and to enable mutual benefit by standardisation of instrument control, data processing procedures, and evaluation software. The Neutron Imaging Group at MLZ, which is managed by Michael Schulz, operates the two neutron imaging instruments ANTARES and NECTAR at MLZ and contributes to the development of the new neutron imaging beam line ODIN, which will be built at the European Spallation Source (ESS) in Lund, Sweden, in collaboration with the Paul Scherrer Institut (PSI), Switzerland, and the ESS, Sweden. While ANTARES is an imaging station located at the cold neutron source of FRM II, NECTAR is a worldwide unique facility that employs fission neutrons for neutron imaging; it is currently being upgraded to additionally provide a thermal neutron beam. Furthermore, the group has access to a microfocus X-ray CT machine. Using this combination of different and complementary neutron spectra together with the X-ray imaging facility allows us to select the technique that is best suited for each application and provide the best possible service for our users. In the following a brief overview of our instruments and their capabilities will be given.



Most of the neutron imaging group members (from left to right): Michael Schulz, Tobias Neuwirth, Dominik Bausenwein, Tommy Reimann, Alexander Backs, Elbio Calzada, Malgorzata Makowska, Michael Lerche, Burkhard Schillinger, Thomas Bücherl.

ANTARES

The ANTARES team:

Michael Schulz, Burkhard Schillinger, Dominik Bausenwein

The cold neutron spectrum available at ANTARES provides high sensitivity to small changes in the composition of a sample. Generally cold neutrons give a strong contrast for materials containing hydrogen, while many metals are very transparent. This, combined with a very flexible choice of collimation ratios, makes the instrument ideally suited for high resolution imaging on small and medium sized samples.

Larger samples can be investigated at a second

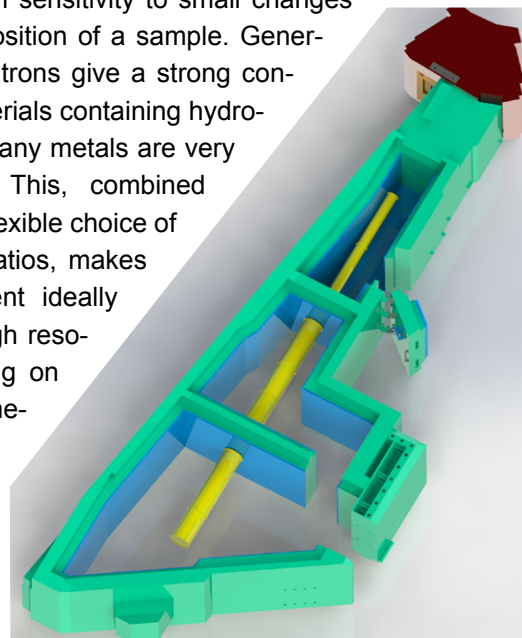

detector position where the beam has a maximum size of $\sim 35 \times 35$ cm. Standard applications of ANTARES include, but are not limited to archaeology and cultural heritage where particularly organic materials can be observed with high contrast, the investigation of pores in geological samples or technical applications such as in-situ investigations of material transport in batteries, fuel cells, and hydrogen storage systems.

Recently, a neutron grating interferometer (nGI) has been installed at ANTARES and is now available as a standard technique for our users. With this new imaging technique, based on an interference pattern generated by three gratings installed on the beam line, the small angle scattering signature of structures in the sample on a length scale of ~ 100 nm to ~ 10 μ m can be observed. This directly connects to the real space resolution of the instrument and extends the sensitivity of the instrument bridging the gap between imaging and scattering techniques. nGI can for example be used to investigate the domain distribution in electric transformer steel blades.

Furthermore, the instrument provides a neutron velocity selector and a double crystal monochromator,

which enable energy selective imaging such as Bragg edge imaging for metallurgical phase identification. Additionally, polarised neutrons can be used to visualise magnetic fields or magnetic properties of materials.

NECTAR

The NECTAR team:
Thomas Bücherl, Malgorzata Makowska

The instrument NECTAR is a unique facility using two Uranium plates placed in the moderator vessel of the reactor to convert thermal neutrons into a fission neutron beam. These fission neutrons show very high penetration even for large samples, while giving a contrast that is perfectly complementary to X-rays. This means that light elements such as hydrogen show strong contrast while heavy elements such as lead or other metals are very transparent. On NECTAR, samples with a maximum size of $\sim 1 \text{ m}^3$ and a weight of up to 800 kg can be investigated with a spatial resolution of the order of $\sim 0.5 \text{ mm}$. Applications of NECTAR include moisture distribution and transport in wood or concrete, in-situ investigations of full-size hydrogen storage tanks and non-destructive testing of large machine parts.

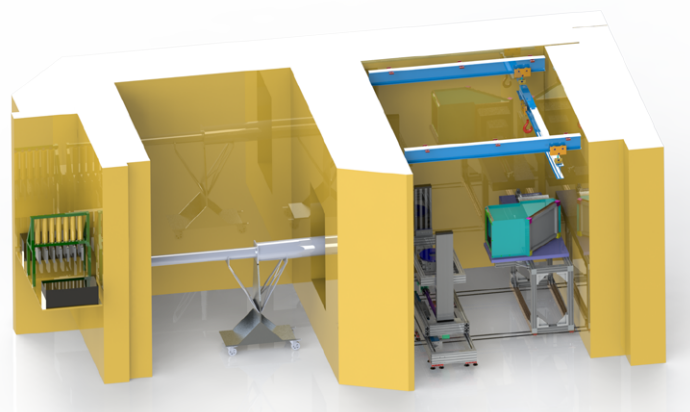

By removing the converter plates and the permanently installed B_4C filter from the neutron beam, NECTAR can also provide a thermal neutron beam which is comparable in intensity and collimation to other state of the art neutron imaging facilities. The advantage of a thermal beam over a cold spectrum is a higher transmission for strongly absorbing materials such as hydrogen or lithium. Furthermore, using thermal neutrons a higher spatial resolution can be achieved than

with fast neutrons. The instrument is currently being upgraded to provide a thermal neutron beam as a standard option enabling multi-modal imaging using fast and thermal neutrons under the BMBF project 05K16VK3.

ODIN

The ODIN team:
Michael Lerche, Elbio Calzada

The experience of our group in designing and building neutron imaging instruments is additionally being used to contribute to the construction of the neutron imaging beam line ODIN at the ESS. ODIN will be a 60 m long Time-of-Flight (ToF) neutron imaging instrument.

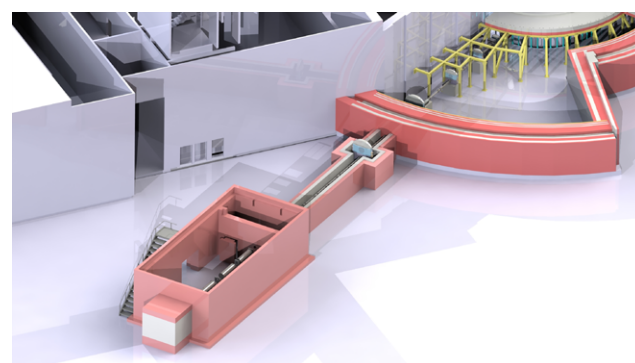

While the white beam intensity will be comparable to ANTARES, ODIN makes use of the intrinsic monochromatisation of the pulsed neutron beam at ESS to obtain much higher performance for all advanced, ToF based techniques requiring a monochromatic neutron beam. To achieve this, a combination of a complex chopper system and neutron guides will be employed. ODIN will be among the first instruments at the ESS to become operational when the source comes online.

M. Schulz (FRM II)

Our PhD's:

Tommy Reimann
Marc Seifert
Alexander Backs

Our students:

Tobias Neuwirth
Severin Angerpointner

New projects – new colleagues!

In this issue, you read a lot about our new projects funded by the Federal Ministry of Education and Research. But projects are nothing without persons! Therefore, we got some new colleagues who will dedicate their work to ODIN, ERWIN, and the Inconel project. We warmly welcome them!



Michael Lerche

I am the project manager of the ODIN instrument, a collaboration of ESS, PSI, and TUM as lead institution. Leading an inter-institutional team, I will oversee and coordinate this collaboration throughout the design and construction phase of this 11.6 M€ project.

ODIN will be a multi-modal beamline offering different imaging techniques, from white-beam to dark field, polarized neutron or Bragg edge imaging, each with unprecedented efficiency and resolution. ODIN takes full advantage of the flexibility enabled by the ESS time structure, allowing wavelength resolution, bandwidth and collimation to be tailored to individual applications in virtually any scientific field.

Alexander Schökel

Alexander Schökel is responsible for finalising the design and building the instrument ERWIN at MLZ. “ERWIN: Energy Research with Neutrons” is a BMBF-funded project aiming to extend the existing single crystal diffractometer (RESI) at the SR8b beam port of FRM II with a high-efficient neutron powder diffraction option. The scientific focus of ERWIN will primarily be on studies of energy materials and/or systems. Before entering the world of neutrons here in Garching he worked as a PostDoc fellow and beamline scientist at the PETRA III synchrotron in Hamburg. There he was in charge for the multi analyzer crystal detector for stroboscopic X-ray diffraction measurements at the HRPD beamline.

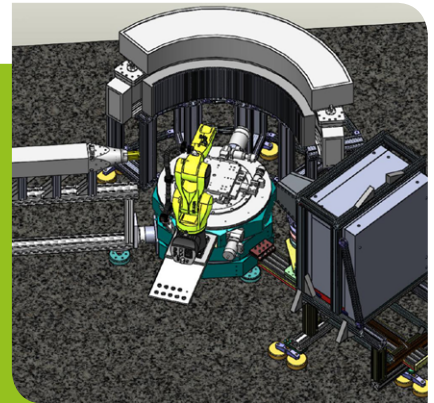

Cecilia Solís

I am a PostDoc working on the Inconel project, in which a testing machine (tension and compression) with furnace and cooling device will be developed in order to investigate the precipitates kinetics of Ni-based superalloys during thermomechanical processes by using ND and SANS.

Before, I obtained my PhD at the Institute of Material Science of Barcelona and I was a postdoctoral researcher for 6 years at the Institute of Chemical Technology in Valencia. My previous work has been focused on advanced functional ceramics for energy applications, and goes from fundamental studies (thin films) to final devices (SOFCs, PC-SOFCs, electrolyzers and solar cells).

Newly arrived at the instruments



Malgorzata Makowska

I'm an instrument scientist at NECTAR, the versatile facility for non-destructive inspection of various objects by means of fission neutron radiography and tomography.

My background lies in applied physics. I finished my PhD almost one year ago at Technical University of Denmark (DTU), where I was working on neutron imaging of **Solid Oxide Fuel Cells (SOFC)**. After that PhD project, I was employed as a PostDoc at DTU, where I was continuing my research on SOFC. I'm interested in the development of devices for energy conversion and storage e.g. fuel cells (e.g. SOFC) and batteries (e.g. Li-ion batteries), but also in the development of neutron imaging techniques.

Phone: +49 (0)89 289 14768

Mail: malgorzata.makowska@frm2.tum.de

Wolfram-Prandl-Prize to Anatoliy Senyshyn

In Kiel on September 21st, again a Garching neutron researcher receives the Wolfram-Prandl-Prize for young scientists in the field of research with neutrons: Anatoliy Senyshyn. He obtains the prize for his outstanding research in the field of lithium-ion batteries, which he watches in its function in a live hook-up at the atomic level.

Senyshyn has contributed not only with new methods for more precise exploration of lithium batteries; he developed a method that allows to examine the spatially resolved distribution of lithium in the anode, cathode and the intermediate areas, says Winfried Petry in the honour of the prize winner. Not only can batteries be investigated with neutrons during their intended use, but also in cases of misuse. For battery researchers this is an experience like for astronomers when viewed through a strong telescope in clear air. Petry comes up with even more acclamation: "His work has not only revolutionised our knowledge of the functioning of these batteries, it also enables developing new models with much better properties."



The newly crowned winner between the eulogist W. Petry (left) and the chairman of KFN T. Unruh (right) is happy about the recognition of his achievements for battery research.

The Wolfram-Prandl-Prize by the "Komitee für Forschung mit Neutronen" was awarded 2002 for the first time for outstanding research with neutrons. The prize is funded by the centres HZG, HZB, FRM II, ILL, JCNS equally and has been awarded every two years to a candidate younger than 40 years.

C. Kortenbruck (FRM II)

Smooth transition in FRM II administration

After ten years, administrative director Klaus Seebach, has retired as of November. His great vision since studying brewery at the Technical University of Munich was to “understand the neutron source” and learn more about the science behind. Starting in 2007, his job began with an important financial project: negotiating the cooperation between the Helmholtz centres Jülich, Geesthacht, Berlin, and Technical University of Munich for the Heinz Maier-Leibnitz Zentrum funded by the Federal Ministry of Education and Research. The result: A solid ten year funding for the MLZ. Besides managing the administration of FRM II with formerly eight and now 16 employees, Klaus Seebach has also kept good contacts with industrial partners and all other neutron centres in Europe. Looking back, the 63-year-old most enjoyed “the scientists’ collegiality and missionary enthusiasm to explain their instruments”. Infected by the scientists’ eagerness, Seebach loved to guide visitors at the neutron source. He offers to be available as a representative for neutron science even beyond his retirement. Though he has a lot of other projects for the next years: exploring Europe by boat, motorcycle, and car as well as spending time with his grandchild.

Johannes Nußbickel shares with Klaus Seebach the long industrial background: They both returned from management positions in industry to university.

Nußbickel’s background as an electrical engineer and M.B.A. led him from EADS into the IT sector with Oracle, Infineon, and mid-size software companies, where he was responsible for finance and administration. He admits a kind of “culture shock” moving from industry to university, but is thankful for the change: “Previously my job was to assure financial transparency, quality and efficiency and augment the value of a company. Now, at FRM II, I can use my experience from industry to serve science and an excellent university.” The 53 year old husband and father of two teenagers, living in Ottobrunn appreciates the two months overlap with Seebach: “For the first time in my professional life, I enjoyed the possibility that my predecessor was still available for questions.” Nußbickel is working on his “puzzle of the FRM II”, but already has an impression of the final picture. He is ready to take on the responsibility as administrative director together with his colleagues in the board, Winfried Petry (science) and Anton Kastenmüller (reactor operation). For the administration, Nußbickel emphasises: “Administration is not a function in itself, but it is an important service role with many tasks and interfaces which have to be managed well: from the internal mail distribution via assuring proper financial information all the way to a reliable reporting to TUM steering committees or Ministries.”

A. Voit (FRM II)



© W. Schürmann (TUM)

Next Proposal Deadline: Jan. 27th, 2017

Find all information

- at mlz-garching.de/englisch/user-office/getting-beam-time.html



© W. Schürmann/ TUM

Submit your proposal at

- fzj.frm2.tum.de
- user.frm2.tum.de

Next Rapid Access Deadline: Jan. 13th, 2017

Accompanying users and training at the lab

In order to make a visit at the MLZ more comfortable – especially for new users or those who only visit us rarely –, the User Office meets you at the reception each working day at 08:30 in the morning since the start of cycle 40.

We will guide you through the access procedure and provide you with information material. Strolling across the site, we head to the entrance building and show you how to find a lab coat as well as safety shoes. Be aware that you are not allowed to enter the halls without that equipment!

The next station is the Radiation Protection Office. Here you have to be checked in and provided with a dosimeter in case you are a scientist working outside Germany. Don't forget to bring the original of your dose report (see an explanation of the new form for "Access to controlled areas of FRM II" on the next page)! The colleagues here check also if you have conducted the online safety training of UWEB, that is valid for one year. Furthermore you may have to register any of the samples you entered in our sample tracker – here is the place for it!

Everything finished? Then it's time to call your local contact who will fetch you. We say goodbye to you!



Teodora Kennel checks the lists of announced users every day.

Since we also reorganised our Sample Preparation Lab, we now have a new colleague in charge of it: Teodora Kennel. You can meet her at the lab each morning and she will be happy to give you a short introduction how to use it and which rules obtain here.



Have a look into the lab!

In the Sample Preparation Lab you will find

- Fume hood
- Glovebox
- H₂O and O₂ < 1ppm, Ar atmosphere, integrated refrigerator
- Refrigerator
- Freezer
- Scales
- Stirrers
- Heating oven
- Ultrasonic bath
- Water purification system
- Centrifuge
- NanoDrop 2000c
- pH-Meter

In addition to the equipment above, the lab provides a supply of argon, helium, compressed air and ultrapure water. Usually small amounts of commonly used solvents and laboratory dishes are available. Additionally you can use the official proposal form to point out your special requirements, so that we can prepare appropriate conditions for your experiment in time!



A user preparing samples.

New form for dose history of foreign scientists

There is a new form asking for the dose history of scientists working outside Germany. This form has to be completed and signed by your radiation protection officer or – in case such a person is not available – the director of your institution and sent to the FRM II Radiation Protection Department (strahlenschutz@frm2.tum.de) at least five days before your experiment starts. This form is NOT valid for scientists working inside Germany!



Forschungs-Neutronenquelle
Heinz Maier-Leibnitz (FRM II)

Technische Universität München
Forschungs-Neutronenquelle Heinz Maier-Leibnitz (FRM II)
Strahlenschutz
Lichtenbergstr. 1, 85748 Garching, Germany
Tel.: +49 89 289 -14955, Fax.: -14405
Email: strahlenschutz@frm2.tum.de

Access to controlled areas of FRM II for scientists/employees of foreign institutions

Please email/fax this form directly to the FRM II Radiation Protection Department
5 working days before your visit starts at the latest.

First, complete your personal data. Don't miss to give the dates of your planned visit!

You did not work in a controlled area during the last 12 months?

Please check the first check box.

Did you work in a controlled area during the last 12 months?

Then please check the second check box **and** provide the requested data/ ask the person in charge to do this. Please note that the last entry must not be older than three months.

In both cases:

The form has to be signed. Without that signature, we unfortunately can't grant any access!

Please fill in the individual information (Please use block letters)		
Institute/Company		
Department		
Street		
ZIP/Postal code, city		
Country		
Surname		
First name		
Date of birth		dd.mm.yy
Sex	female <input type="checkbox"/> male <input type="checkbox"/>	
Start of Visit		End of Visit
		dd.mm.yy
<input type="checkbox"/> Non-occupationally exposed person (Did not work in controlled areas during the last 12 months)		
<input type="checkbox"/> Occupationally exposed person (Please complete the following only in case of an occupational radiation exposure)		
Last medical examination (if available)		dd.mm.yy
Annual dose limit		in mSv
Lifetime dose until 31.12. of last year		in mSv
Monthly whole body dose of the current year	January	in mSv
	February	
	March	
	April	
	May	
	June	
	July	
	August	
	September	
	October	
	November	
	December	
<input type="checkbox"/> Further Information		

I confirm that the doses were communicated correctly and that the employee is instructed to obey the radiation protection and safety regulations of FRM II.

Place and Date

Name Radiation Protection Officer/
Director of the institute/Member of the
Management

Signature and stamp of
Institute/Company

Wird vom Strahlenschutz FRM II ausgefüllt:

Monat/Jahr: _____

XX-Film: _____

Upcoming

MATRAC 2 – Winter School 2017

Feb. 27 - March 03, Utting/ Ammersee + Garching
(Germany)

www.hzg.de/ms/summerschool/058653

DPG Spring Meeting of the Condensed Matter Section

March 19 - 24, Dresden (Germany)

dresden17.dpg-tagungen.de

[Visit our booth there!](#)

48th IFF Spring School

**Topological Matter – Topological Insulators,
Skyrmions and Majoranas**

March 27 - April 07, Jülich (Germany)

www.fz-juelich.de/pgi/EN/Leistungen/SchoolsAndCourses/SpringSchool/_node.html

PARI 2017 - Workshop on Public Awareness of Research Infrastructures

May 29 - 30, Garching (Germany)

webapps.frm2.tum.de/indico/event/43/

MLZ Conference – Neutrons for Health

June 26 - 30, Bad Reichenhall (Germany)

[Have a look for our circular emails with detailed information!](#)

Reactor Cycles 2017

No.	Start	Stop
41	24.01.2017	24.03.2017
42	03.05.2017	01.07.2017
43	08.08.2017	06.10.2017

Imprint

Editors

Rainer Bruchhaus

Flavio Carsughi

Connie Hesse

Christine Kortenbruck

Ina Lommatzsch

Jürgen Neuhaus

Andrea Voit

Layout and Typesetting

Ramona Bucher

Ina Lommatzsch

Contact

Forschungs-Neutronenquelle

Heinz Maier-Leibnitz (FRM II)

User Office

Lichtenbergstraße 1

D-85747 Garching

Phone: +49.(0)89.289.10794
10703
11751

Fax: +49.(0)89.289.10799

e-mail: useroffice@mlz-garching.de

www.mlz-garching.de



wishes
happy holidays
and
a happy New Year!

KOMPASS

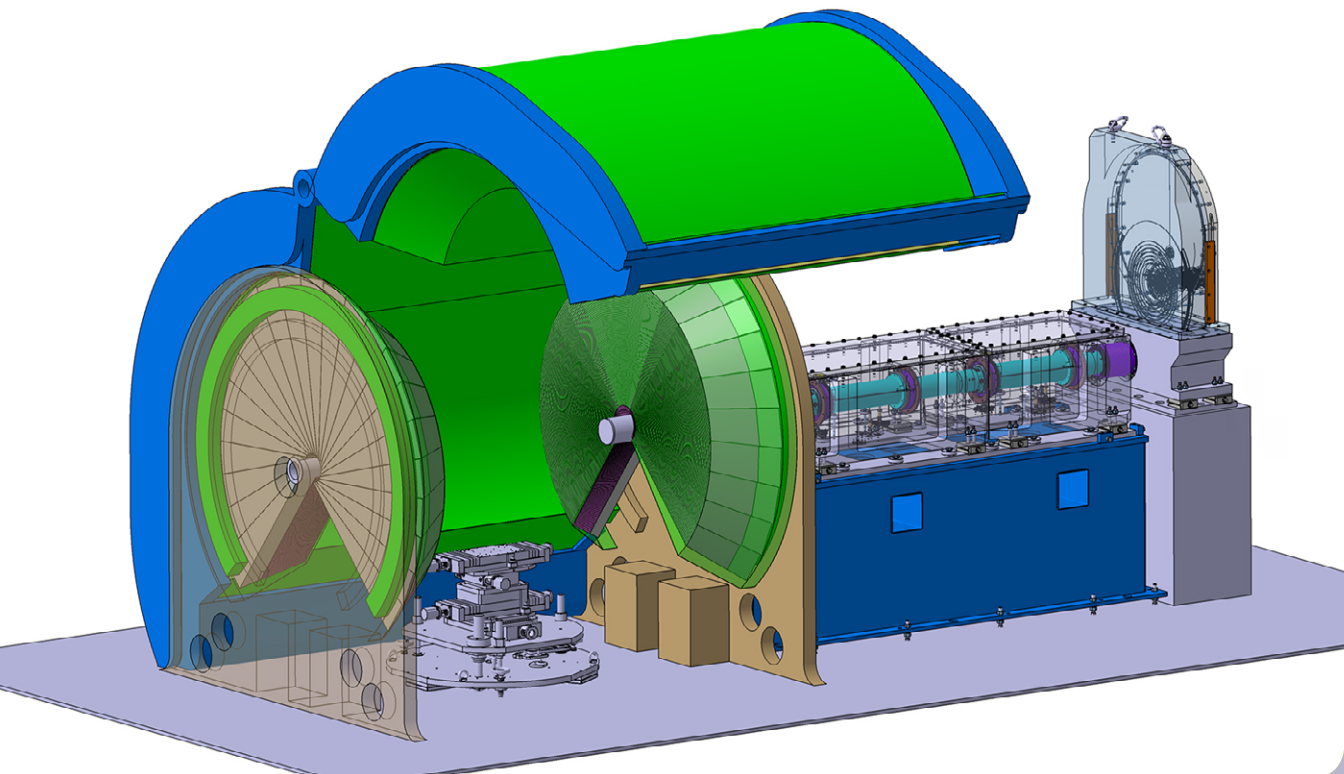
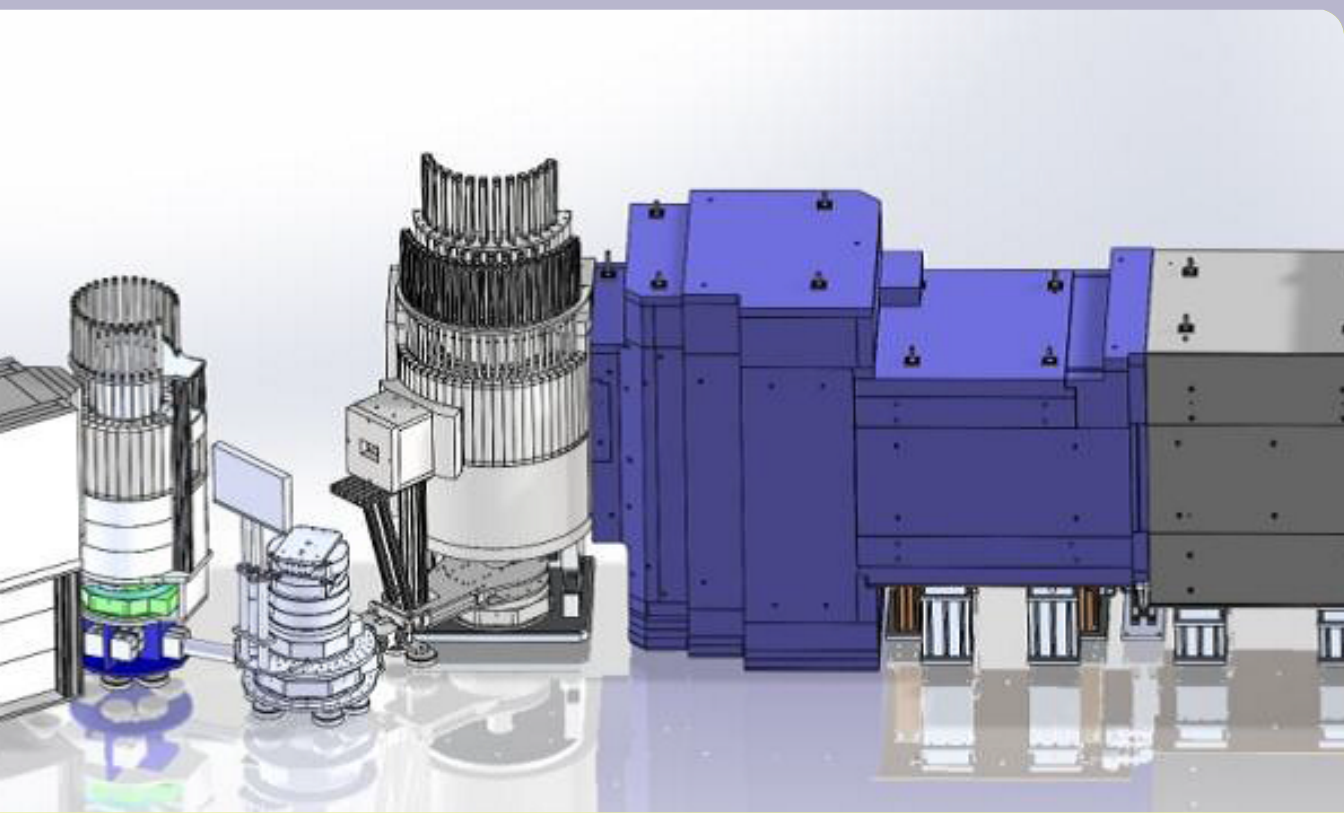

POWTEX