



# Heinz Maier-Leibnitz Zentrum

Neutrons for Research, Industry and Medicine



# News



## Three new capital letters mark the forefront in neutron research:



MLZ – the Heinz Maier-Leibnitz Zentrum - represents the collaboration of the Technische Universität München and three Helmholtz Centres, namely the Forschungszentrum Jülich, and the Helmholtz Centres in Geesthacht and Berlin to exploit the scientific use of the FRM II at the science campus in Garching. The collaboration is embedded in a network of partners consisting of ten university groups and institutes from the Max Planck Society to offer cutting edge research facilities with neutrons and positrons.

Even more, MLZ is a unique endeavor to join the forces of leading university groups with strong research centres. The high creativity of excellent young researchers is combined with the scientific continuity following long term perspectives in basic research with the objective to provide an excellent scientific infrastructure with high innovation capacity. MLZ aims to embrace all aspects of neutron research, from education to a scientific service facility.

The goal is to leverage synergies between the MLZ-partners to continuously improve our service in instrumentation, offer a wide spectrum of sample environment equipment for the experiments and additional laboratory facilities for complementary methods. By doing this we carefully listen to the needs and requirements of our users as a valuable input for the future development of the MLZ.

To strengthen the scientific focus of the MLZ we have founded six science groups representing the relevant science fields at the MLZ, covering materials science, soft matter, quantum phenomena, structure research, astro- & particle physics and neutron methods. Instrument scientists and postdoctoral researchers join the group which is most relevant to their own research interest. Our target is to form and deepen the scientific exchange with groups from research institutions and universities from the greater Munich area and form a platform for future projects.

The three capital letters MLZ for the Heinz Maier-Leibnitz Zentrum stand for our promise to offer a wide spectrum of neutron scattering instrumentation at one of the best neutron sources in the world in conjunction with the best service for the scientific users.



*Prof. Dr. Winfried Petry*  
Scientific Director MLZ  
Technische Universität München



*Prof. Dr. Dieter Richter*  
Scientific Director MLZ  
Forschungszentrum Jülich GmbH

# Content

Don't miss our Special Feature  
**Introducing MLZ**  
pages 4-7

## Instrumentation

J-NSE .....	8
NREX .....	9
KWS-1 .....	10
KWS-2 .....	12
KWS-3 .....	13
MIRA .....	14
NEPOMUC .....	16
PGAA .....	18
MARIA .....	19

## Events

MAUD – Materials Analysis using Diffraction .....	20
DPG Spring Meeting .....	21
Workshop on Grazing Incidence Scattering Software .....	21

## Science & Projects

Rotatable Multifunctional Load Frames .....	22
Casting and In-situ Neutron Diffraction .....	24
NMI3: European Research in Garching .....	26
In-situ Experiments for Texture Analysis .....	28

## Outside

KFN: The German Neutron Community is Strong and Young! .....	30
---	----

## Inside

Newly Arrived .....	31
The Infrastructure Group .....	32
From Beijing to Munich: A Visiting Scientist at the MLZ .....	33
PR at the MLZ Reinforced! .....	33
MLZ Efforts for a Better Education and Training .....	34

## User Office

The MLZ User Office's New Web Pages .....	36
Proper Acknowledgements .....	37
Experimental Reports .....	37
User Satisfaction Survey .....	38
Rapid Access Programme .....	39
Two Subcommittees "Magnetism & Spectroscopy" .....	40
MBE System: Available for the First Time .....	40
Long Maintenance Break in 2014 .....	40
Call for Proposals .....	41
Upcoming .....	42

Don't miss the Proposal Deadline  
**July 19<sup>th</sup>, 2013**  
page 41

## Welcome to the Heinz Maier-Leibnitz Zentrum!

MLZ is the new landmark for the forefront in neutron research. Utilizing the neutron source FRM II, the Technische Universität München (TUM) and the three research centres of the Helmholtz Society Forschungszentrum Jülich, Helmholtz-Zentrum Geesthacht (HZG) and Helmholtz-Zentrum Berlin (HZB) unite their competences in Garching, Germany, and started a collaboration in 2011. Heinz Maier-Leibnitz was chosen as its patron with good reason: In his field, he was a pioneer and mentor. Based on his initiative and under his direction the first German neutron research reactor (ForschungsReaktor München, FRM), the well known “atomic egg”, went into operation in Garching in 1957 and paved the way for subsequent reactor projects and neutron research in Europe. About a decade later, Heinz Maier-Leibnitz became one of the founders of the Institut Laue-Langevin in Grenoble, France, with its high-flux neutron source. Until his retirement in 1974, he was professor for Technical Physics at the TUM and director of the FRM. From 1974 to 1979 he served as president of the Deutsche Forschungsgemeinschaft (DFG, German Research Foundation).

Our goal: Joining scientists from universities and research centres for the benefit of neutron research in Germany and abroad. Based on a unique suite of neutron scattering instruments, cutting edge service for national and international users shall be offered. To achieve this, MLZ relies on a network of strong partners:

- the Forschungs-Neutronenquelle Heinz Maier-Leibnitz (FRM II),
- the Jülich Centre for Neutron Science (JCNS),
- the German Engineering Materials Science Centre (GEMS) at HZG,
- ten German universities,
- institutes of the Max Planck Society.



Fig. 1: Key representatives from the neutron science community all around Europe at the MLZ inauguration.

The collaboration receives additional funding by the German Federal Ministry of Education and Research (BMBF) with an annual budget of 19.8 Mio €. Under auspices of the Forschungszentrum Jülich, the Helmholtz Centres financially support support MLZ with additional 10.52 Mio € per year. The TUM is the sole operator of the neutron source. The State of Bavaria is funding the reactor operation and research annually with 25 Mio €.

### Ceremonial act: Inauguration of the MLZ

The inauguration of the MLZ was celebrated on February, 21<sup>st</sup>, 2013. Representatives from the funding partners, namely Beatrix Vierkorn-Rudolph of the BMBF and Adalbert Weiß of the Bavarian State Ministry of Sciences, Research and the Arts opened the ceremony. They were followed by the President of the TUM, Wolfgang Herrmann, and the chairs of the German and European Neutron Scattering Associations, Tobias Unruh and Michael Steiner. Finally the directors of the MLZ, Dieter Richter (Forschungszentrum Jülich) and Winfried Petry (FRM II/ TUM), outlined the goals of our collaboration, inaugurated the new MLZ logo and launched the web page mlz-garching.de. A thrilling lecture on the importance of neutron research for the society given by the ILL director Helmut Schober concluded the first part of the ceremony.

After the series of speeches the honourable guests and staff members of the MLZ joined the coffee break, taking the opportunity for follow-up discussions on past and future endeavours related to neutron research. In the evening the guests resumed for a festive dinner in the Wirtshaus am Bavariapark in downtown Munich. About 220 persons enjoyed best Bavarian food and music as a grand finale of MLZ's day 1.

### Extending capabilities: On the way to the new guide hall East

An ambitious and challenging project within the MLZ is the setup and the hookup to the neutron beams of the new Guide Hall East. Located underneath the JCNS office and laboratory floor this guide hall provides sufficient space to house several new instruments which considerably expand the MLZ's instrument suite. The challenges for the infrastructure teams of the MLZ and the neutron source operation are twofold. First, this originally conventional building needed to be converted into a building as part of the nuclear installation of the FRM II. Technical upgrades like the separation of radiation protection areas are associated with a tremendous amount of paperwork. Second, the neutron beams have to be directed into the guide hall and the instruments therein. To achieve this the initially separated reactor building and the Guide Hall East need to be connected by a new

Fig. 2: Planning of the instruments' arrangement in the Neutron Guide Hall East.

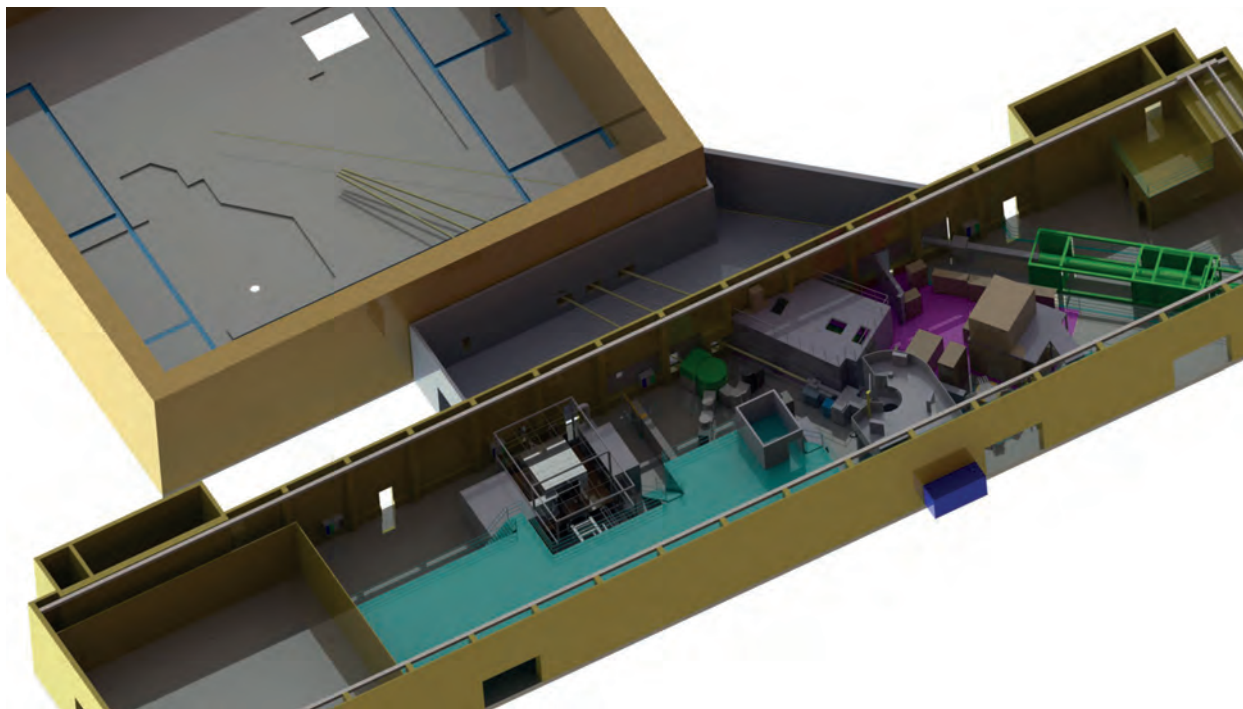

building. This new building hosts a major part of the neutron guide system including beam conditioning devices like choppers. The body shell of the new building will be completed in autumn 2013.

At the same time instrument construction and installation is under full steam. As reported in our last newsletter, the first parts of two new instruments already arrived. The multi-anvil press of SAPHIR was installed and the magnetic shield of the EDM experiment is on place. A project in collaboration with the Physikalisch-Technische Bundesanstalt (PTB) Berlin aims to use this unique environment for high precision experiments prior to the arrival of the ultra-cold neutrons in the Guide Hall East. The impressive vacuum chamber of the time-of-flight spectrometer TOPAS is under construction, built up and tested at the Forschungszentrum Jülich and will be brought by heavy load to Garching later this year.

When ready, the Guide Hall East will be served by one guide with cold neutrons, three guides from beam tube 5 with thermal neutrons, an ultra-cold neutron guide as well as a positron beam line. Figure 2 gives a glance on the actual planning concerning the arrangement of instruments. The cold neutron guide will be used by the instrument MEPHISTO for particle physics. A first large experiment already under construction stems from the international PERC collaboration (in fig. 2 on the outermost right hand side). The thermal beams will be used in a combined way by the instruments POWTEX (RWTH Aachen, University of Göttingen, JCNS) and SAPHIR (University of Bayreuth), by the new time-of-flight spectrometer TOPAS (JCNS, central beam) and the third

guide by the high resolution three axes spectrometer TRISP (MPI Stuttgart) which will move from the Experimental Hall. The same goes for the positron beam line at NEPOMUC and all its experimental stations (PAES, CDBS, PLEPS, open beam port) including those under construction (ARPES, PM).

#### Scientific collaborations: New structure defining Science groups

Instrument operation within the MLZ is organised along the partners. This structure, however, does not reflect the fruitful scientific cooperation between the partners, the associated university groups and the group from the Max Planck Society. To overcome this obstacle and to strengthen the scientific focus of the MLZ science groups were founded. These groups represent fields of research relevant to the work at the MLZ. Within these groups instrument scientists as well as postdoctoral researchers and master and PhD students of the whole MLZ are brought together. Scientists working on-site of the MLZ join the group which is most relevant to their scientific interest. A group coordinator oversees the different groups. Additional postdoc positions were installed to release the group coordinators partially from their duties as responsible instrument scientists and local contact for the users.

The work on astro- and particle physics is very closely linked to the strong group formed by the ultra-cold neutron source project.

The groups work at the interface between the scientists of the MLZ and the numerous groups at nearby universities

and research institutions around the science campus in Garching. A lively scientific exchange with these groups and the organisation of additional seminars and workshops form the nucleus to improve existing and trigger new collaboration projects. The MLZ groups improve the relations to leading science groups in the field and these groups can benefit from the world class instrumentation and the excellent know-how of the instrument scientists based at the centre. Innovative research projects at the MLZ ensure an optimal support for our external users by competent scientists as local contacts.

Science Group	Group Coordinator
Materials Science	R. Gilles and M. Hofmann (deputy)
Soft Matter	H. Frielinghaus
Quantum Phenomena	Y. Su
Structure Research	A. Senyshyn
Neutron Methods	P. Link
Astro- and Particle Physics	linked to the UCN-project

Tab. 1: Science groups and corresponding coordinators.

The science groups are asked to develop science roadmaps in their relevant scientific fields. For this ambitious task the input from the user groups is crucial. The science roadmaps form the basis for the input to improve the neutron scattering instruments and the sample environment equipment for the users' future needs. Thus, the science groups strengthen the scientific focus of the MLZ and are a key element for a prosperous future development of neutron research at the campus in Garching and in Germany.

### Presenting to the outside world: The new website

The new website [mlz-garching.de](http://mlz-garching.de) was launched in the context of the inauguration of the MLZ. It prominently presents the scientific cooperation for the scientific usage of the FRM II to the public in general and to the scientific users in particular. Since they are the main target group, one major focus is to provide them with all relevant information in order to perform experiments at the MLZ, regarding allocation of beam time, access, funding, experimental methods, application examples, instrumentation details, and important contact information. Moreover, the general public is addressed providing detailed information about the MLZ, the broad and exciting field of neutron research and how neutrons can help to find solutions to the important issues of modern societies, the so-called grand challenges.

The navigation with its three-level hierarchy guides everyone easily to the required information. The content

is subdivided in the task bar into seven sections based on the different topics of interest:

- About MLZ (General information including some historical milestones)
- News & Media (Presentation of results and publications)
- Neutron Research (Overview about experimental methods and applications using neutrons or positrons)
- Instruments (Experimental facilities at the MLZ)
- Science & Projects (Application examples in the field of neutron research as well as presentation of scientific projects performed at the MLZ; education and training programs)
- Industry & Medicine (Industrial & medical applications)
- User Office (Practical information on the access to the MLZ)

To ensure that [mlz-garching.de](http://mlz-garching.de) stays up-to-date and remains attractive, the website working group will have a constant critical review of the content and its presentation. Input from the user community is very welcome and should be directed to [mlz@mlz-garching.de](mailto:mlz@mlz-garching.de) - Thank you in advance!

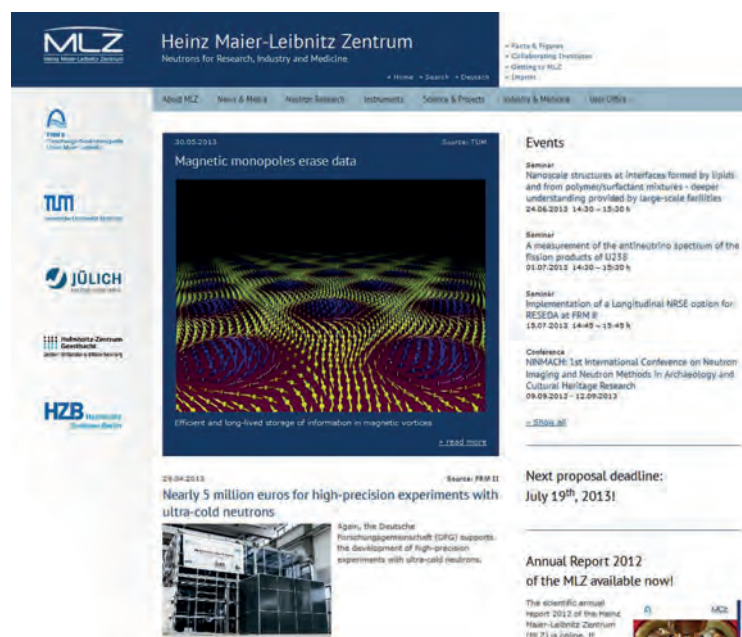

Fig. 3: The MLZ home page.

### User Office at full speed: Rapid access for users

A common practice at major neutron facilities around the world is a biannual proposal submission procedure to distribute the available beam time at the instruments. Such well established peer review system is a compromise between the work load acceptable for the international referees, and the scientific users' urgent need for

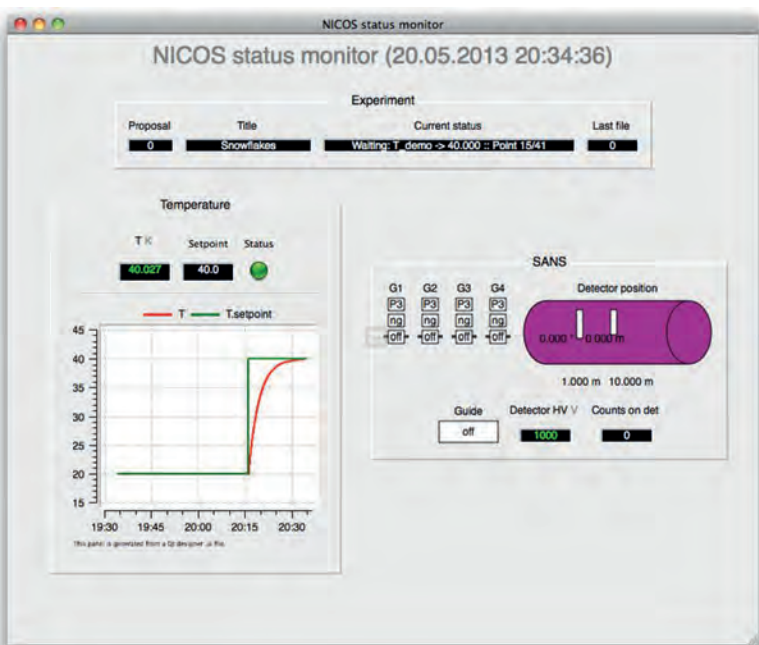

Fig. 4 + 5: Instrument control seen from the user perspective using NICOS (above) at SANS-1 (right, view into the detector tank).

beam time. For very short experiments where neutrons can deliver a small but significant contribution to a scientific project, however, this procedure with delays up to one year between the idea and the realisation of an experiment is not suitable. Therefore we grant access to a limited number of instruments and for a restricted number of days within a Rapid Access mode. The conditions explained on page 39 are a first approach to start and might be changed in future based on the feedback of our users.

#### Look and feel:

##### Merging instrument control software

Conducting experiments at the MLZ, from the perspective of our scientific users, means to a large extent controlling the instrument during the measurement. Therefore, a powerful and at the same time user friendly instrument control software is required at all experimental stations. Over the last few years several concepts, especially for the user interface were developed by the instrument scientists in close collaboration with the software group in order to accomplish the specific needs of different kinds of instruments. For further development and to strengthen synergies a merge of approved and tested tools and concepts is one of the major duties of the instrument control group at the MLZ.

In its current form, the instrument control software consists of several layers, from sending commands and receiving data from the electronics, communication between different instrument components up to the user interface. Whereas the lowest level relies on a distributed system of dedicated servers, the communication is

based on the well established TACO system in use right from the beginning of the instrumentation at the MLZ. During the last years a lot of effort was spent to develop a modular, network based user interface named NICOS (**N**etwork **I**ntegrated **C**ontrol **S**ystem) constituting the higher levels. Here all the required setups of the instrument prior to the measurement's start are defined. This enables our users to control all details of the experiment, from the configuration of the instrument and its parameters to the control of the sample environment. A powerful suite of control tools is provided ranging from online status displays to a logbook of the measurements which can be taken home by the experimental team.

*R. Bruchhaus, F. Carsughi (JCNS)*

*C. Hesse, J. Neuhaus, I. Lommatzsch (FRM II)*

## “Slow Motion Pictures“ feat. The Beast

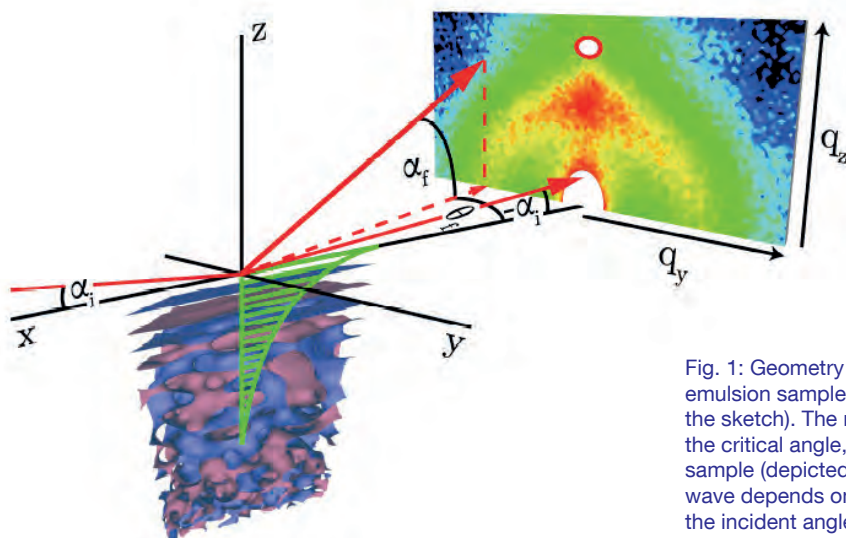

Fig. 1: Geometry of the GINSES experiment for a bicontinuous microemulsion sample close to the rigid Si interface (on top, not shown in the sketch). The neutron beam hits the sample with an angle below the critical angle, and an evanescent neutron wave is penetrating the sample (depicted in green). The scattering depth of the evanescent wave depends on the contrast between sample and Si-block and on the incident angle.

J-NSE aka „The Beast“ [1] has had a sheltered upbringing and is now in user operation for over five years. The main focus of the experiments has been soft matter dynamics, with some excursions to the territories of magnetism. Typical experiments probe thermally activated motions on length scales of several nm and time scales of ~1–200 ns, complementing structural information obtained from SANS. But also smaller timescales down to some ps and larger  $q$ -values (i.e. shorter length scales) up to  $\sim 1.5 \text{ \AA}^{-1}$  are accessible.

In the field of soft matter dynamics, one central question which runs like a golden thread through this period of operation is the effect of confinement on macromolecular motion.

On the one hand, confinement in nano-channels of different size, geometry, and stiffness was one major area of investigation, on the other hand a new field of near interface dynamics emerged.

**Grazing Incidence NSE Spectroscopy (GINSES)**, the dynamic analog to GISANS, has been established as a tool to investigate dynamics close to the rigid interface of a silicon block as a function of distance to the block, with a sensitive region of ~40-100 nm, depending on contrast and incident angle. The scattering geometry is shown in fig. 1, where the red circle in the GISANS-picture denotes the  $q$ -position of GINSES measurements for a first series of experiments on bicontinuous microemulsions. The incident angle is typically of the order of some  $0.1^\circ$  and requires a much better collimated beam (at least in one direction) than in usual NSE experiments. Despite the extremely low intensity of evanescent wave scattering with a collimated beam, the low background and high instrumental stability allowed to record the intermediate scattering function and to observe the influence

of the rigid wall on the thermal membrane fluctuations. Such bicontinuous microemulsions (fig. 1) get oriented close to the interface, this lamellar structure shows a faster relaxation than the bulk membrane due to the interface – membrane interaction of the first layers [2].

The coolest experiment came from the small fraction of hard matter experiments at the J-NSE and was carried out at temperatures below 100 mK (fig. 2), where evidence of nuclear spin waves in a  $\text{Nd}_2\text{CuO}_4$  crystal has been observed [3].

*O. Holderer, O. Ivanova (JCNS)*



Fig. 2: Harald Schneider working hard to provide 25 mK at the J-NSE. During this experiment, the J-NSE has been the coolest place in the neutron guide hall. In this example nuclear spin waves of a  $\text{Nd}_2\text{CuO}_4$  crystal were investigated.

### References

- [1] FRM II news 1, „A New Beast in the Guide Hall: J-NSE“.
- [2] Frielinghaus et al., PRE 2012.
- [3] T. Chatterji et al.



## Revealing Even More: Increased Contrast at NREX

The quality of all scattering techniques relies in two ways on contrast. First, on the detector signal's contrast, which is governed by a high incident flux and a low signal to background ratio; second, on the minimum resolvable contrast of the scattering length densities of the sample. So in general, improvement of the experimental technique based on a scattering method means increasing the contrast. In this sense we massively upgraded NREX by

- suppression the background,
- increasing the neutron flux,
- using polarized neutrons to increase magnetic contrasts, combination of neutron and X-ray scattering to allow for contrast variation.

The result: NREX is now competitive with the leading reflectometers at other high-flux reactors.

Let's have a look at the instrument's scheme (fig. 1). NREX is an angle-dispersive fixed-wavelength machine with a default wavelength of  $\lambda = 4.3 \text{ \AA}$ . The monochromatization of the beam is provided by a redesigned focusing monochromator **M**. This focused beam increases the neutron flux by a factor of 3 for small samples of  $5 \times 5 \text{ mm}^2$ . The wavelength band reflected from the monochromator is variable, thus allowing to switch between the modes "high intensity/relaxed resolution" and "high resolution/reduced intensity". An efficient and reliable suppression of higher order reflection from the monochromator is realized by a cooled Beryllium filter **Be**. A polarization analysis is provided by the high efficiency  $m = 3.5$  transmittance supermirror polarizer **P**, analyzer **AP**, and gradient RF field spin flippers **SF1** and **SF2**. Neutrons are detected with a pencil or a  $20 \times 20 \text{ cm}^2$  position sensitive detector (PSD) **D** and the beam is collimated by the slits **S1**, **S2** and **S3**.

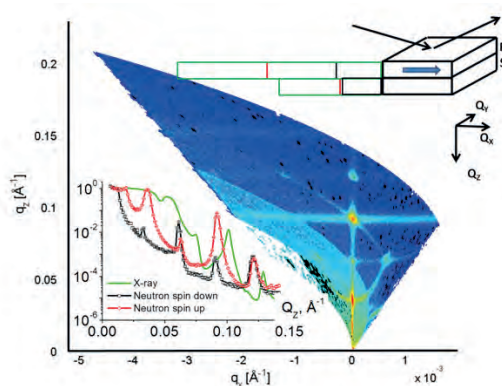

Fig. 2: Scattering-map of spin-up neutrons from the  $[\text{Fe}(10\text{nm})/\text{Si}(10\text{nm})] \times 50$ -multilayer measured in magnetic field  $H = 1\text{ kGs}$  applied in-plane of the structure. Left-bottom inset: specular reflectivities of neutrons and X-rays. Peaks on reflectivity curves correspond to the Bragg scattering from the periodic Fe/Si superstructure. Positions of the peaks for different channels are shifted due to refraction effects. Right-up inset: scheme of the reflectometric experiment and schematic representation of scattering length density profile of the structure for spin-up (red), spin-down (black) neutrons and X-rays (green).

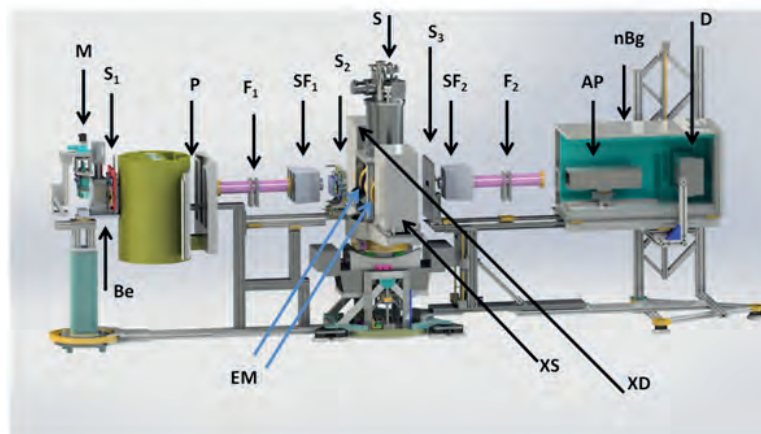

Fig. 1: Scheme of NREX. **M** = monochromator, **Be** = beryllium filter, **S1-S4** = slits, **P** = polarizer, **SF1, SF2** = spin flippers, **S** = sample goniometer, **EM** = electromagnet, **nBg** = background shielding, **AP** = analyzer, **D** = neutron detector. **X** = X-ray part (works without magnet): **XS** = X-ray source, **XD** = X-ray detector.

At NREX, much attention is paid to suppress the background. To prevent neutron scattering on air, two vacuumized flight tubes **F1** and **F2** are installed before and behind the sample. Furthermore, the neutron detectors are hidden in the background shielding box **nBg**. Efforts on increasing flux and suppressing the background have led to the possibility to measure 6 orders of magnitude with full polarization analysis on small samples of  $5 \times 5 \text{ mm}^2$ . One of the features of NREX is the sample's horizontal orientation. This gives us several opportunities. First, the detector arm can move horizontally at an angle as much as  $90^\circ$  allowing perform **Grazing Incidence Neutron Diffraction** and **Small Angle Neutron Scattering** (GIND and GISANS) experiments. And second, the horizontal alignment allows performing simultaneous neutron and X-ray experiments. To this end, an X-ray source **XS** and the detector **XD** are installed orthogonal to the neutron path. Thus combination of neutron and X-ray measurements allows contrast variation and hence more reliable information about studied structure.

A typical example for neutron and X-ray scattering data from a  $[\text{Fe}(10\text{nm})/\text{Si}(10\text{nm})] \times 50$  sample shows fig. 2. The contrast of the channels is different which leads to the different scattering pictures. Complex analysis of the neutron and X-ray specular data allows obtaining detailed information about structural and magnetic properties of the Fe and Si layers (thickness, density, magnitude and direction of magnetic induction). Moreover, the presence of PSD at the neutron experiment allows us to measure simultaneously the intensity of specular ( $Q_x = 0$ ) and off-specular ( $Q_x, Q_y \neq 0$ ) scattering. Both together open up the opportunity to study in-plane properties of the systems with typical dimensions of  $100 \text{ \AA} \div 1 \text{ \mu m}$  (via diffuse scattering,  $Q_x \neq 0$ ) and  $3 \text{ \AA} \div 100 \text{ \AA}$  (via GIND/GISANS,  $Q_y \neq 0$ ) at NREX.

*Yu.N. Khaydukov, O. Soltwedel, F. Tralmer, M. Ohl, T. Keller, B. Keimer (MPI Stuttgart)*

## Towards Magnetism: KWS-1 Upgraded

The KWS-1 is a small-angle scattering instrument dedicated to high resolution measurements due to its 10% wavelength selector. The instrument is operated by the JCNS and is installed at the NL3b “S”-shaped neutron guide of the FRM II neutron source. It had been in operation since 2009. In the beginning of the 2013, the instrument went into upgrade phase and it is planned to be back in operation in the second half of this year. The main goal of the upgrade is to strengthen the scientific background of the KWS-1 in the direction of magnetism and magnetic materials.

The high resolution of the instrument is interesting for highly ordered or highly monodisperse samples. With the foreseen chopper the wavelength uncertainty can be reduced further to ca. 1%. The chopper will be installed right after the end of the “S”-shaped neutron guide. The chopper discs are made from aluminum coated with  $^{10}\text{B}$  and will be used in a fixed position with respect to each other allowing for a window opening of variable size according to the  $\Delta\lambda/\lambda$  needed. A rotation frequency of the two-disc tandem of maximum 200 Hz is foreseen. Classical soft-matter systems will be investigated on KWS-1 if the resolution is needed. Biological samples can be handled due to the detector distance of ca. 1 m, which will allow for maximal scattering angles of  $Q = 0.5 \text{ \AA}^{-1}$ . Additionally the chopper system may be used for experiments in time-of-flight mode.

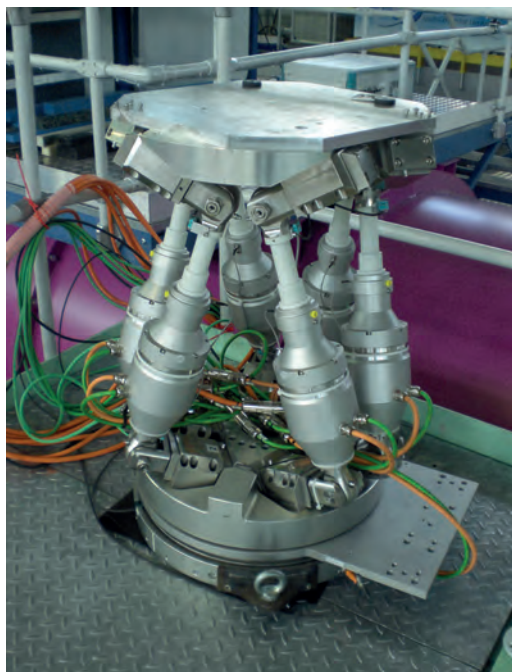

Fig. 1: Hexapod during software tests (outside of the sample position for convenience).

The KWS-1 has a custom designed hexapod at the sample position. The hexapod can carry up to half a ton of useful load. The six feet enable flexible positioning and trajectories of the sample - by single stepper motors,

this is difficult to achieve. As it has been built by exclusively non-magnetic materials, no shielding is necessary even if it carries magnets with high magnetic fields. The high precision of the hexapod (0.01 mm and  $0.01^\circ$ ) will allow also the investigation of magnetic nanoparticles deposited on substrates and thin films of nanostructured polymeric materials by **Grazing Incidence Small-Angle Neutron Scattering (GISANS)** with the application of magnetic field on the sample. A special adaptor was made to mount the 5 Tesla vertical cryomagnet on its table (300 kg). Moreover, another vertical electromagnet of 1.5 Tesla (500 kg) will be equipped with a temperature-controlled sample changer. Both magnets are shielded and have weak stray fields.

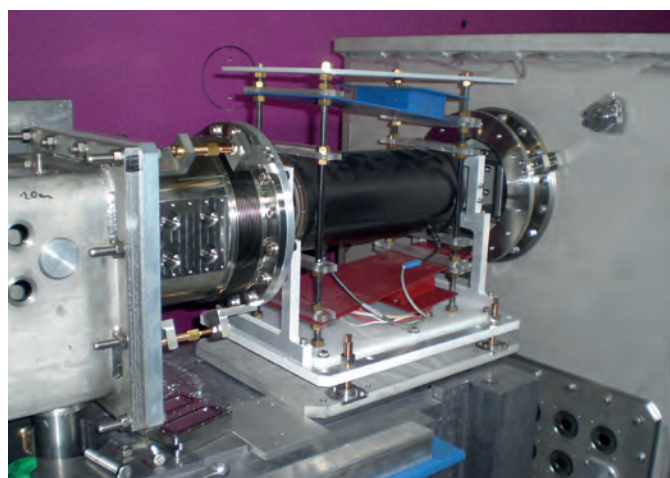

Fig. 2: Radio-frequency spin flipper (neutron guide goes through it).

For the intensity enhancement a set of  $\text{MgF}_2$  lenses will be installed 1 m before the sample position. Different modes of using the neutron lenses are defined to focus the beam on the detector depending on the neutron wavelength. Thus, for neutrons of  $7 \text{ \AA}$  wavelength all lenses will be moved into the beam while for  $18 \text{ \AA}$  wavelength only four lenses will become active. In the so-called high flux mode with large sample areas the instrument resolution stays in the classical SANS range. These enhanced intensities make real time measurements in the 1/10 second region (typical 1 s) possible. The chopper in parallel allows for studying faster dynamics in the ms range. The so-called TISANE mode interlocks the chopper frequency with the excitation field frequency and with the detection binning. The precise consideration of the flight times results in higher precision compared to classical stroboscopic illuminations.

Magnetic samples will be studied with the full polarization analysis including incident beam polarization and polarization analysis of the scattered neutrons. The polarizer will be installed at the end of the “S”-shaped neutron guide between the chopper and the entrance to the collimation line. In order to switch between a polar-

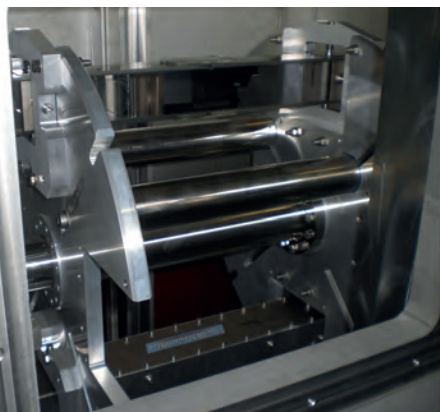
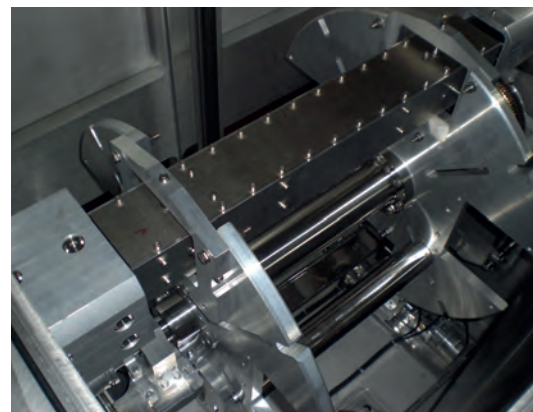

Fig. 3: Polarizer revolver with polarizer and neutron guide (left – neutron guide in beam, right – polarizer in beam).



ized and unpolarized configuration a custom designed automatic changer of revolver type will be installed with the possibility to insert four different devices. One position will carry a neutron guide for unpolarized neutron scattering. Another one will be equipped with a 3-channel V-cavity Fe/Si-polarizer with  $m = 3.6$  (cross-section  $50 \times 50 \text{ mm}^2$ ). The full length of the polarizer section is 65 cm. The full bandwidth of 4.5 to 20 Å will be covered with min. 90% (95% typical) polarization. The other two positions will remain empty and be reserved for future upgrades. In order to achieve the best polarization of the neutron beam the revolver is equipped with five motors for precise tuning of the polarizer in beam (height and translation movement  $\pm 5 \text{ mm}$ ). The reproducibility of the revolver positioning is better than 30  $\mu\text{m}$  and  $0.003^\circ$ .

A radio-frequency spin flipper right after the polarizer chamber allows for changing the polarization to the opposite. The coil of the flipper is made of the litzendraht wire in order to be operated at frequency of 77 kHz. The flipper was specially designed for large beam cross-sections and thus it fully encloses the neutron guide inside. Without external signal the flipper simply transmits the polarized beam. Once the signal is applied, the flipper will flip the neutron polarization to the opposite with the probability better than 99% for neutron wavelengths of 3.5 Å and larger. Starting from the polarizer, all 20 m of the collimation line (inclusive lenses) of KWS-1 is equipped with a guiding field of minimum 15 Gauss (stacks of permanent magnets between steel plates). Moreover, the coating of the neutron guides is non-magnetic so that there will be no loss of polarization during the neutrons' flight to the sample.

The polarization analysis will be realized with  $^3\text{He}$ -cells which will be optimized for the used wavelength and scattering angle. The analyzer will be placed right in front of the detector tube. It will make it possible to measure all four spin-flip and non-spin-flip channels ( $I^{++}$ ,  $I^{+-}$ ,  $I^{-+}$ ,  $I^{--}$ ). Inhouse made **Spin-Exchange Optical Pumping** (SEOP) cells from GE180 glass will be used as analyzer cells. In the conventional mode polarizations of 75% and lifetimes of 300 hours can be expected. Moreover,

the KWS-1 is planned to be equipped with the in-situ SEOP. Thus, neutron experiments performed using in-situ SEOP method will not need time-dependent corrections to analyze the data.



Fig. 4: Chopper chamber, polarizer chamber and spin flipper (the big installation in front of the collimation).

The equipment of KWS-1 with polarizer, flipper and analyzer will open new possibilities of the studies of magnetic materials. As an example one can study domain structure of ferromagnetic materials, vortices in superconductors, magnetic fluids (ferrofluids), magnetic thin films, complex magnetic nanoparticles like dimers and much more. Besides that, soft matter materials like polymers, proteins, carbon nanotubes, hydrogen storage materials etc. can be studied in a conventional SANS mode with the additional possibility of using large sample areas to increase intensity on the sample with the help of lenses and the use of a chopper for dynamical measurements.

We would like to acknowledge all the staff involved in the upgrade of the KWS-1 from JCNS, ZEA-1 and ZEA-2 of the Forschungszentrum Jülich GmbH.

*A. Feoktystov, H. Frielinghaus,  
M.-S. Appavou, Z. Di (JCNS)*

## Boosting Performance of the KWS-2 High-Intensity Wide Q-Range Small-Angle Neutron Diffractometer with Tunable Resolution

The small-angle neutron diffractometer KWS-2, operated by JCNS, is dedicated to the investigation of mesoscopic structures and structural changes due to rapid kinetic processes in soft condensed matter and biophysical systems. It was recently subject of a major upgrading aiming for boosting its performance with respect to the intensity on the sample, the instrumental resolution, and the Q range covered. The instrument was equipped with focusing elements. Thus, 26  $\text{MgF}_2$  parabolic lenses grouped in three packages which can be automatically brought into the beam either separately or in a combined way for matching the focusing conditions for different neutron wavelengths and collimation-detection conditions were installed. Furthermore, KWS-2 now has a double-disc chopper with variable slit opening and working frequency between 7 and 200 Hz and a secondary high-resolution position-sensitive detector (pixel size of 0.45 mm) at its disposal. It is fixed at 17 m after the sample and can automatically be moved into the beam when the main detector is parked at the end of the 22 m long detector tank.

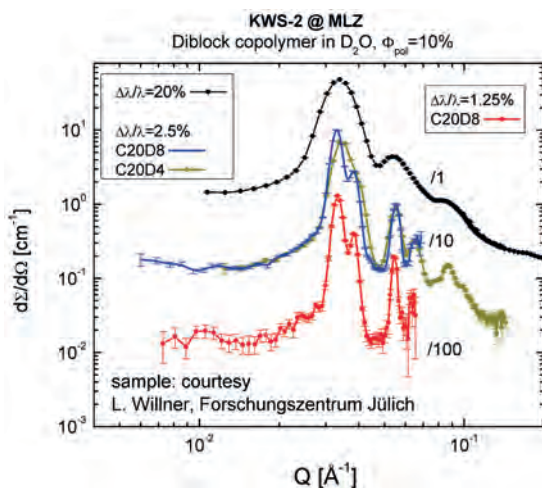

Fig. 2: Measurements with variable resolution carried out on structures formed by a n-alkyl-PEO system in  $\text{D}_2\text{O}$ , at high polymer volume fraction.

The flexibility and versatility of the instrument were enhanced by the commissioning of the new options which, besides the conventional pinhole setup, became operational in 2013:

- The high-intensity mode, with lenses. Up to 12 times intensity gain (fig. 1) compared to the conventional pinhole mode for the same resolution can be achieved with lenses based on increasing of the sample size, up to 5 cm in diameter; in order to suppress the pho-

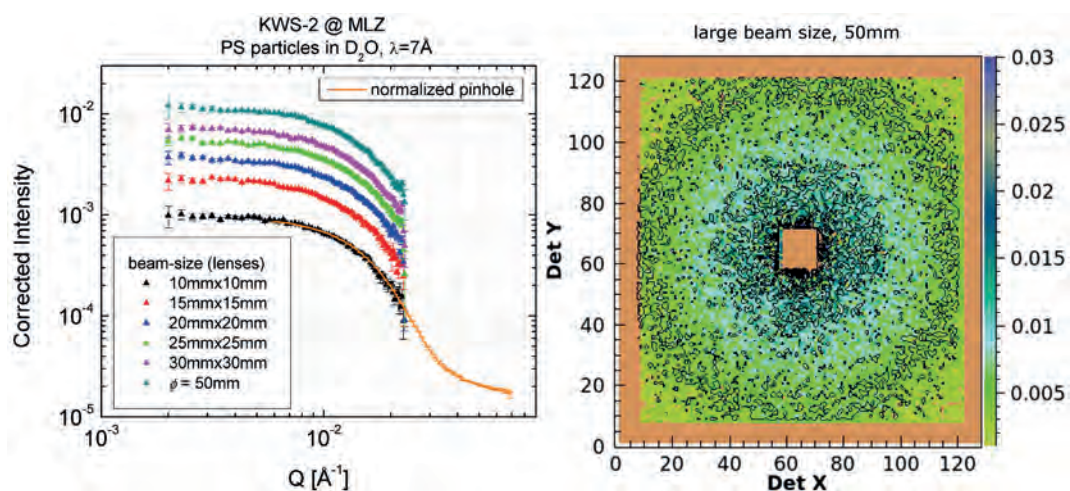

Fig. 1: The intensity gain on the sample with lenses compared to the conventional pinhole mode, due to increasing of the beam-size (left) for the same resolution (right).

non scattering and to increase the transmission the lenses are used at 70 K ( $T = 67\%$  with 26 lenses for  $\lambda = 7 \text{ \AA}$  and the full lens area used).

- The tunable resolution mode, with chopper. It enables improved characterization of the scattering features within different Q ranges by the possibility to vary the wavelength spread delivered by the velocity selector  $\Delta\lambda/\lambda$  between 1% and 20% (fig. 2).
- The extended Q-range mode (down to  $1 \times 10^{-4} \text{ \AA}^{-1}$ ) by means of lenses, chopper and high-resolution detector, which in combination with the pinhole mode, permits the exploration of a continuous length scale from 1 nm to one micron. The lenses focus small entrance apertures on the high resolution detector, enabling thus the detection of much smaller angles than in the conventional pinhole mode, while the gravity and chromatic effects are resolved by using the data acquisition in time-of-flight, with the chopper.

A. Radulescu (JCNS)

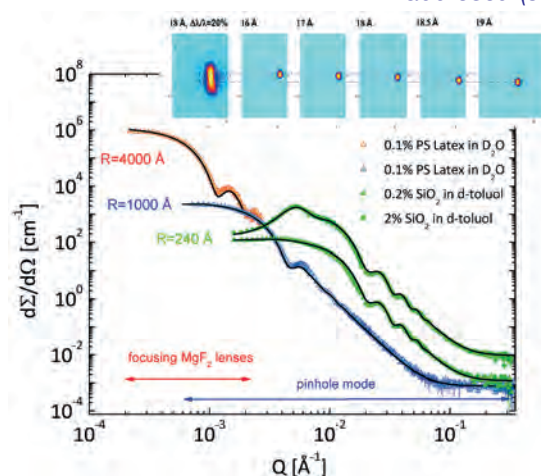

Fig. 3: The complete Q-range which can be explored at KWS-2 combining the conventional pinhole and the focusing (lenses) mode; the inset shows how the chromatic and gravity effects present for the 20% wavelength spread data are resolved using the TOF data analysis for an aimed wavelength spread of 5%.

## Flux Boosting at KWS-3

During the last two years, the incoming white flux at the **Very Small Angle Neutron Scattering (VSANS)** mirror focusing diffractometer KWS-3, operated by JCNS, was five times improved as well as the monochromatic flux at the sample position gained more than four times. This flux boosting crucially changed the experimental strategy at the instrument:

- we can measure smaller samples,
- the same sample can be measured faster, and
- we can get scattering signals from more weakly scattering samples.

KWS-3 was built to investigate the structural information of objects in the micrometer and sub-micrometer size range ( $Q$ -range between  $10^{-4}$  and  $2 \cdot 10^{-3} \text{ \AA}^{-1}$ ), where classical techniques like pinhole SANS and **Double Crystal Diffractometers (DCD)** have very low flux even at the best instruments or need a very long acquisition time even per single point in  $Q$ . With the boosted flux we have already tested a very high-resolution mode of the instrument with  $Q_{\min} = 2.5 \cdot 10^{-5} \text{ \AA}^{-1}$ , and reached the resolution of a double crystal diffractometer. Currently, KWS-3 is the highest flux VSANS instrument worldwide with excellent signal-to-noise ratio ( $>10^5$ ) and flexible  $Q$ -range ( $>$  three decades).

After the instrument's relocation from Jülich to Garching, the flux at the sample position was increased by a factor of seven - but this factor was far away from the predictions of Monte Carlo simulations. A lot of efforts were spent to reach the simulated flux:

- The instrument "adjustability" was improved to be able to find the optimal position of the entrance aperture as well as the mirror's position in order to use beam directions with maximum flux.
- The vacuum was extended and the flux monitor was moved out from the "used" beam coming to the focusing mirror.

- The last element of the neutron guide (vertical trumpet) was changed to a straight guide (produced and replaced by the in-house neutron optic group) in order to increase the beam's horizontal divergence and fully illuminate the mirror.
- The old neutron guide splitter between KWS-2 and KWS-3 was replaced due to "de-coating" by a new one from boron-free glass also produced by the neutron optic group.

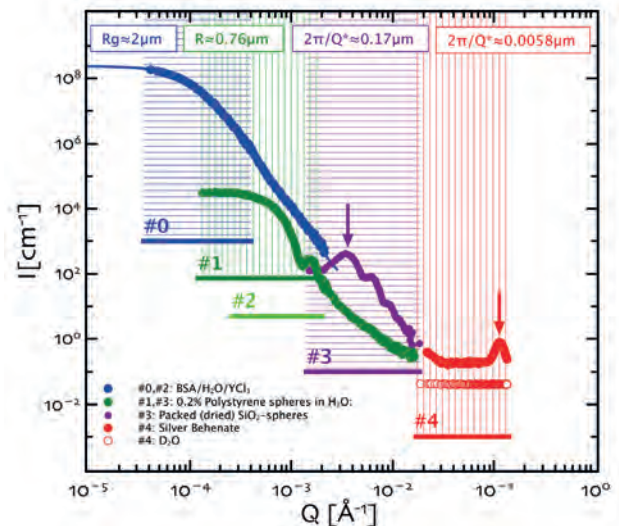

Fig. 1: Scattering patterns of the samples measured at different configurations of KWS-3. Corresponding parameters of the instrument for configurations #0-#4 are listed in table 1.

Protein dense phase of BSA/H<sub>2</sub>O/YCl<sub>3</sub> solution after liquid-liquid phase separation (thanks to Marcell Wolf, University of Tuebingen) was measured in configuration #0 by hybrid pixel detector QT-PX-262k (resolution  $< 55 \mu\text{m}$ ) kindly offered for the instrument resolution test by Amsterdam Scientific Instruments company.

Soon, KWS-3 will cover three decades in  $Q$  between  $2.5 \cdot 10^{-5} \text{ \AA}^{-1}$  and  $2.5 \cdot 10^{-2} \text{ \AA}^{-1}$ , and users will be able to choose from different desirable instrument configurations. In table 1, five configurations of KWS-3 are listed. Three configurations (#1-#3) are already open for users,

covering a  $Q$ -range between  $10^{-4} \text{ \AA}^{-1}$  and  $2.5 \cdot 10^{-2} \text{ \AA}^{-1}$ . With the last configuration (#4), the sample is located in the focus and the detector moves out from the focus on 15 cm. This configuration could be used for the detector's or selector's calibration as well as for educational proposes. The very-high-resolution option (#0) will be open for users after the installation of the second detector with a resolution better than  $200 \mu\text{m}$ . In figure 1 the usage of KWS-3 in different configurations is shown.

V. Pipich (JCNS)

#	$Q_{\min}$ [ $\text{\AA}^{-1}$ ]	$\lambda$ [ $\text{\AA}$ ]	D [m]	CA [mm x mm]	SA [mm x mm]	Count Rate [n/sec]	Status
#0	$3.5 \cdot 10^{-5}$	12.8	9.50	0.5 x 0.5	100 x 20	1200	[ waiting for detector ]
#1	$1.4 \cdot 10^{-4}$	12.8	9.50	2.0 x 2.0	100 x 20	18000	[ in user operation ]
#2	$2.5 \cdot 10^{-4}$	12.8	9.50	5.0 x 5.0	100 x 20	105000	[ in user operation ]
#3	$1.4 \cdot 10^{-3}$	12.8	1.30	5.0 x 5.0	12 x 8	105000	[ in user operation ]
#4	$1.8 \cdot 10^{-2}$	12.8	0.15	5.0 x 5.0	5 x 5	105000	[ instrument calibration ]

Table 1: Possible configurations of KWS-3. Configurations #1-#3 are in the routine user operation. Configuration #4 is used for detector sensitivity measurement and selector calibration. Configuration #0 will be open for users after obtaining of a very-high-resolution detector.

In header: CA means Collimation Aperture, SA maximal Sample Aperture, D sample-to-detector Distance.

## New Three Axes Mode of MIRA

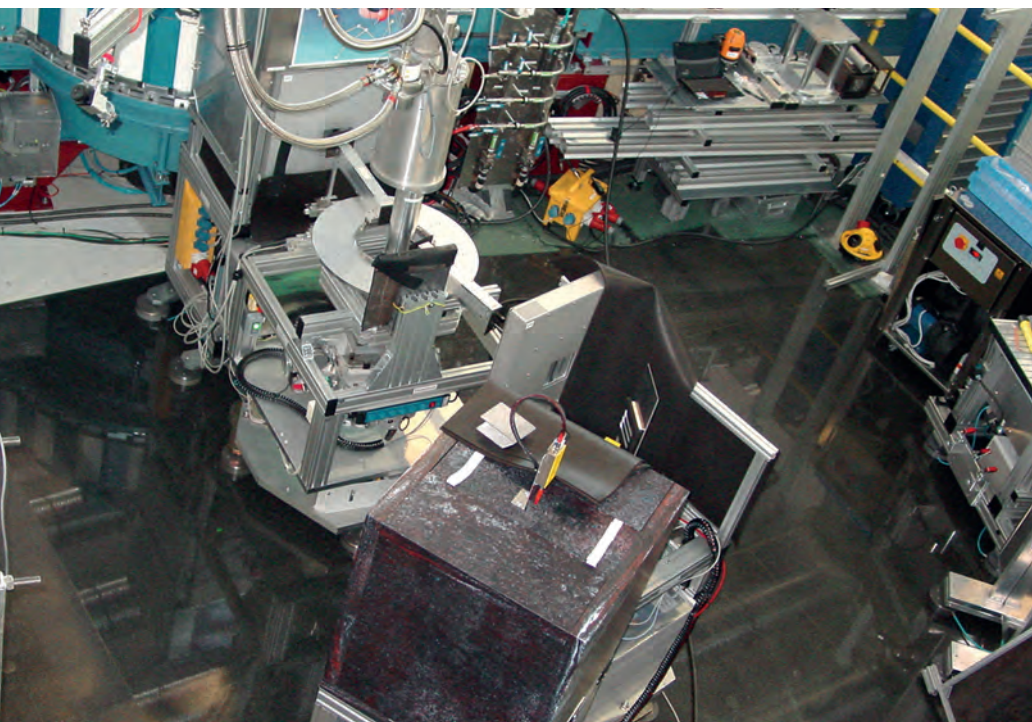

Fig. 1: The set up at MIRA.

During the last year, a cold three axes mode for MIRA had been implemented. It is especially designed for measurements with cold neutrons on small samples under extreme conditions such as high pressures and large magnetic and electric fields. The instrument uses HOPG crystals as analyser and monochromator. The latter is vertically focussing and provides neutrons with incident wavevectors of  $1.20 \text{ \AA}^{-1} < k_i < 1.56 \text{ \AA}^{-1}$  and a flux of  $1.4 \cdot 10^7 \text{ n/cm}^2\text{s}$  at the sample position at  $1.40 \text{ \AA}^{-1}$ . Scattering angles up to  $125^\circ$  can be used. A background rate of about 0.3 counts per minute is measured inside the 30 cm thick polyethylene shielding of an 1-inch  $^3\text{He}$  counting tube. The control software NICOS is used at

MIRA like on the other three axes instruments PANDA and PUMA. Thus the user interface is identical for all three spectrometers, what makes it very comfortable for users carrying out experiments at different instruments. Test measurements of the TA phonons in lead (see fig. 2) indicate a three times smaller intensity than at the dedicated cold three axes instrument PANDA.

Due to the position of the instrument at the neutron guide NL6, the instrument can unfortunately only be operated in the constant- $k_i$  mode, because otherwise the instruments located behind MIRA would be hindered in their operation by a moving monochromator. Nevertheless for application at higher temperatures the instrument can be operated at the energy loss side of the excitation spectrum. An example for this mode is shown in fig. 3, where the spin wave cones and the so-called Fincher burke modes in Chromium were measured at 140 K with MIRA up to -10 meV. For a comparative evaluation, the same sample was measured at IN12 at the Institut Laue-Langevin and the results are shown in the left part of the figure. These measurements were performed on the energy gain side and show the same behaviour as the one carried out at MIRA.

Usually, inelastic measurements using three axes spectrometers require large sample volumes, as the scattering signal is mostly rather small. This limits the TAS-method considerably because most new and interesting materials are difficult to grow and therefore only available as small crystals. MIRA is now equipped with a set of elliptically focusing guides, which allow to focus more neutrons on the sample and also accept neutrons from

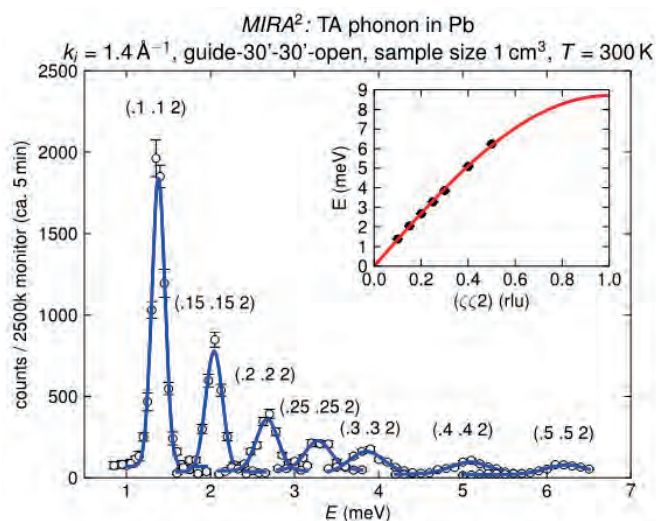

Fig. 2: Test measurements on TA phonons in lead. In the inset, the resulting dispersion relation is shown. The resulting flux is three times smaller than at PANDA.

Fig. 3: The incommensurate inelastic scattering and the Fincher Burke mode of Cr. Left the measurement of MIRA on the energy loss side compared to the one at IN12 at the ILL.

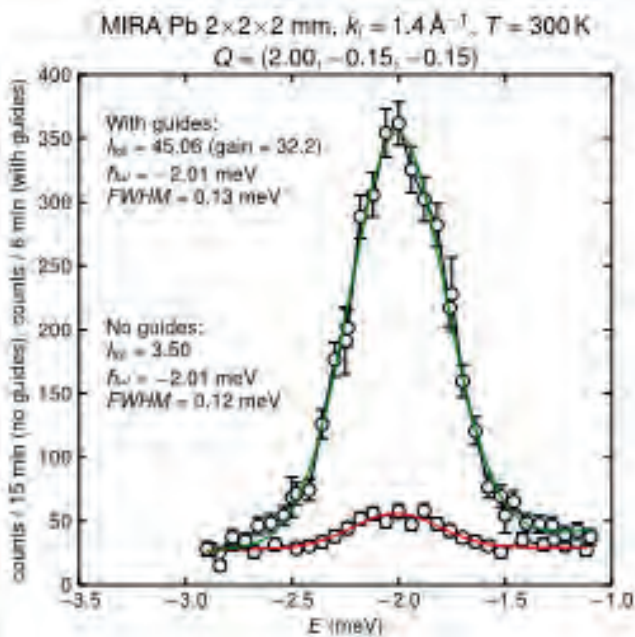
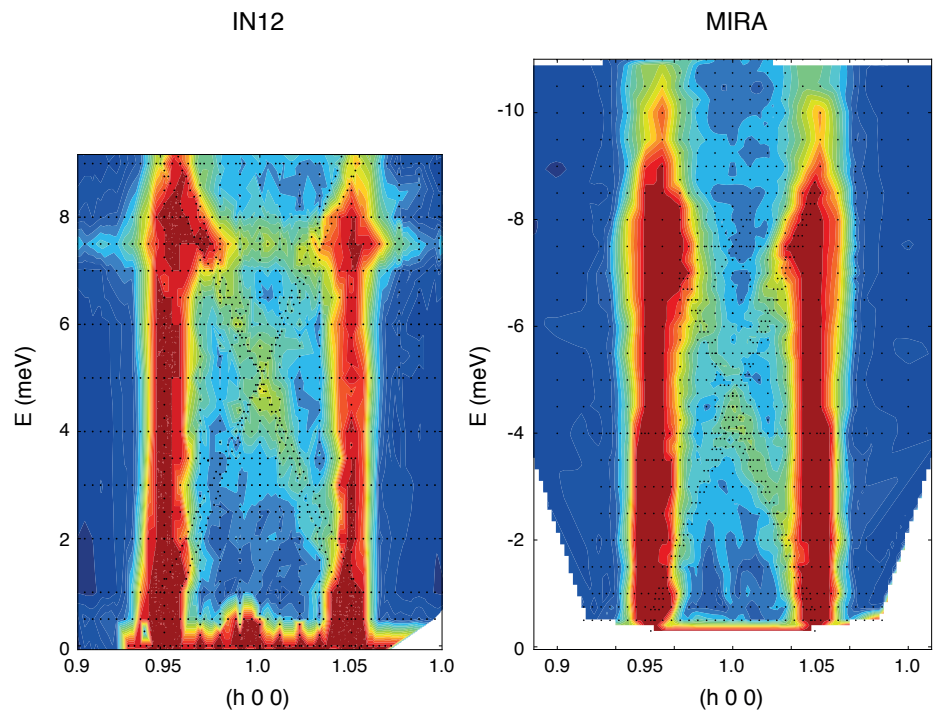

Fig. 4: Comparison of measurements of a transverse phonon in lead with and without focusing guides (for the setup see fig. 1). Intensity gain factors in the order of 30 have been obtained.

a large solid angle from the sample. This new technique helps to conduct measurements on samples as small as 2 mm x 2 mm x 2 mm, thus also offering the possibility to measure samples in pressure cells or other complex sample environments. In fig. 4, the results of comparative measurements of a small sample of lead with and without the focusing guides indicate a gain factor of more than 30 in inelastic intensity.

The results up to now show that MIRA can be operated efficiently in the three axes mode. Using elliptically focusing guides it become possible to successfully perform inelastic neutron scattering from small samples in extreme environments.

*R. Georgii, G. Brandl, R. Schwikowski (FRM II)  
P. Böni, S. Dunsiger (TUM)*

## Back to Work: The Positron Beam Facility at NEPOMUC

Starting in the end of 2010 major parts of the positron beam line and two spectrometers had to be removed completely due to the reconstruction of the neutron tomography facility ANTARES at the Forschungs-Neutronenquelle Heinz Maier-Leibnitz (FRM II). In the same period the beam tube SR11 was dismantled and replaced by the new **NE**utron induced **PO**sitron Source **MU**niCh (NEPOMUC) upgrade. In 2012 NEPOMUC was successfully put into operation, the positron beam facility was rebuilt and first instruments have been connected to the beam line.

The reason for the replacement of SR 11 was the burn-up of  $^{113}\text{Cd}$  in the cusp of the beam tube after five years of reactor operation. Therefore, the main change of NEPOMUC upgrade is the application of highly enriched  $^{113}\text{Cd}$  as neutron-gamma converter in order to ensure an operation time of 25 years.

The cross-sectional view of the new in-pile positron source is shown in fig. 1. The absorption of gamma radiation, which is released by the cadmium cap, leads to the production and moderation of positrons in a structure of platinum foils inside the beam tube SR11. The moderated positrons are electrically extracted and magnetically guided to the positron instruments in the experimental hall of FRM II. The whole design of NEPOMUC has been improved in order to enhance both the intensity and the brightness of the positron beam. Recent meas-

urements confirmed the unprecedented intensity of  $>10^9$  moderated positrons per second. Hence, NEPOMUC provides the world highest intensity of monoenergetic positrons that enables a large variety of positron beam experiments in solid state and surface physics, materials science, and atomic physics in the long-term.

Outside the biological shield, the primary positron beam can be guided to a remoderation unit with a tungsten single crystal in back reflexion geometry for brightness enhancement [2]. A new beam switching device allows quick toggling between the primary high-intensity and the high-brightness remoderated positron beam [3]. Presently, the positron beam can be switched to five different experimental stations (see fig. 2):

- **Positron annihilation induced Auger-Electron Spectroscopy – PAES:** PAES has been demonstrated to be an excellent technique for the investigation of surfaces with topmost layer sensitivity. After most successful experiments at NEPOMUC until 2010 new surface studies have been started with the extended spectrometer in the beginning of 2013 in order to compare the results with conventional X-ray induced photo electron spectroscopy.
- **Coincident Doppler-Broadening Spectroscopy – CDBS:** The CDB spectrometer allows the examination of defects near the surface and in the bulk up to a few  $\mu\text{m}$  according to the maximum positron implan-

Fig.1: Cross-sectional view of the new in-pile positron source NEPOMUC upgrade in the beam tube SR11 at FRM II (from [1]).

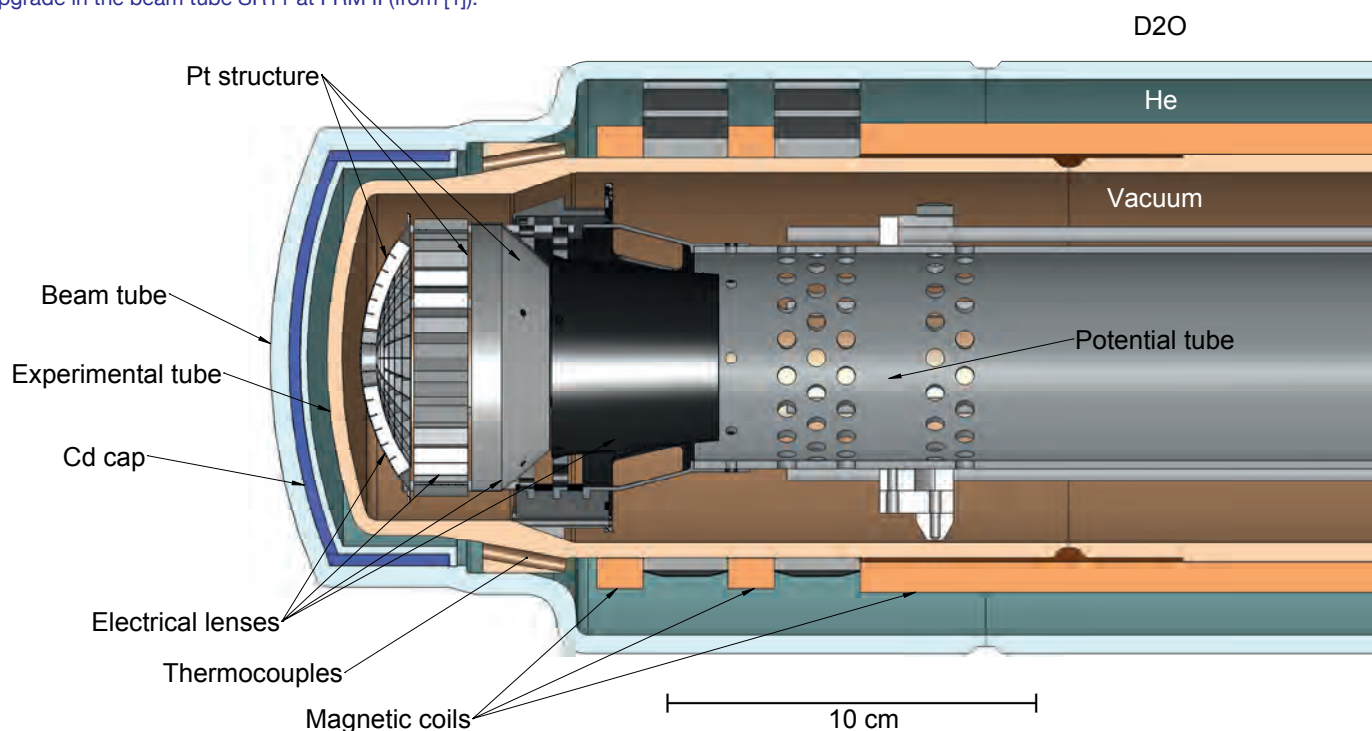



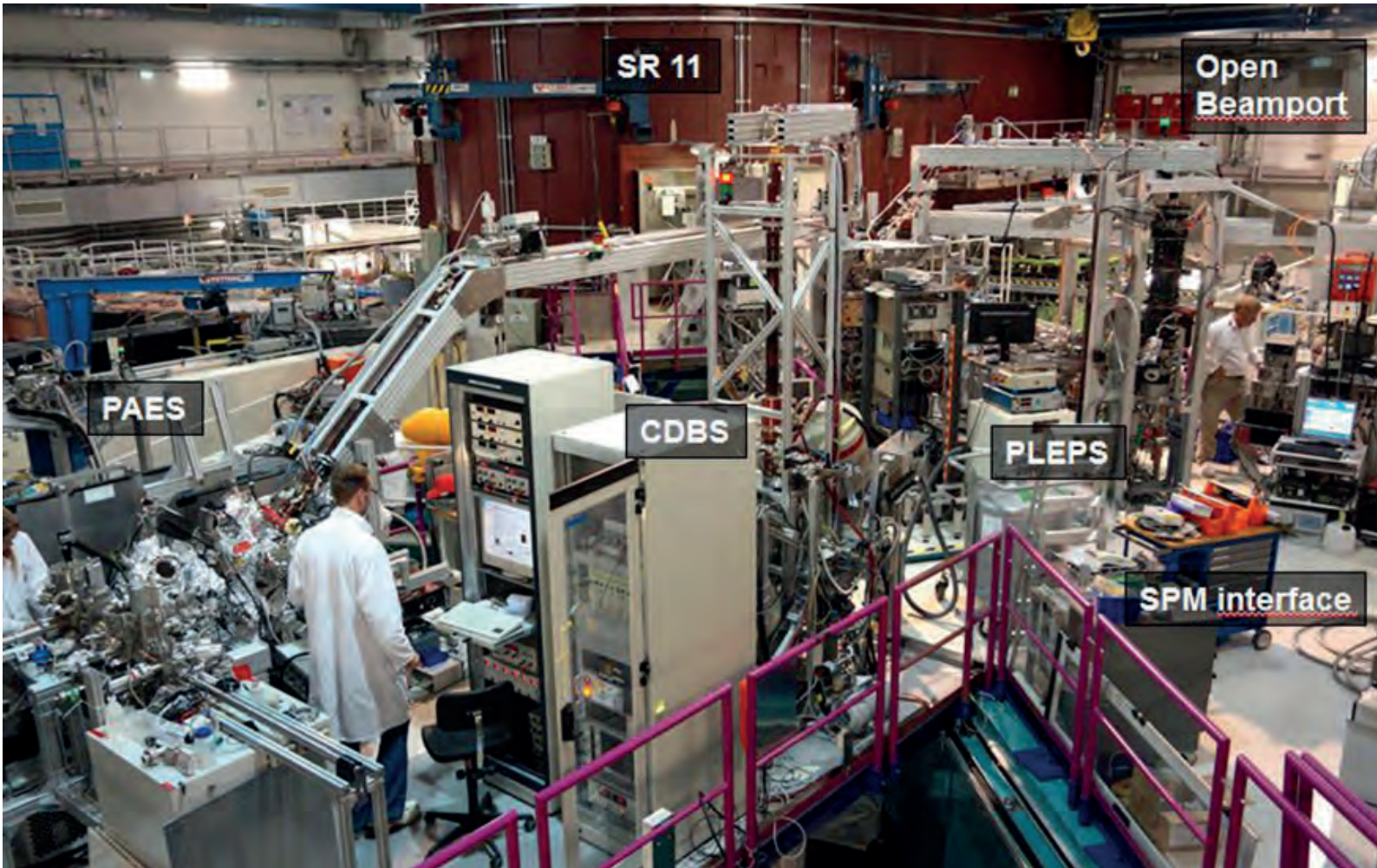

Fig. 2: View onto the positron beam facility with several spectrometers at NEPOMUC.

tation energy of 30 keV. A positioning device enables position resolved measurements with a lateral resolution of 300  $\mu\text{m}$  in order to image vacancy-like defects. In addition, element specific information in the surrounding of defects is gained that plays a major role e.g. for the understanding of precipitation growth in metallic alloys. Defect annealing up to a temperature of 1100 K can be investigated in-situ using a newly designed heating device.

- **Pulsed Low-Energy Positron System – PLEPS:** Positron lifetime measurements in thin layers are performed with the pulsed positron beam at PLEPS. The positron lifetime in matter provides unique information about vacancy-like crystal defects in metals, semiconductors or insulating materials. Amorphous materials, e.g. thin polymer films, can be characterized by the positron lifetime in the free volume.
- **Scanning Positron Microscope – SPM:** An experimental interface is currently installed in order to enable the operation of a positron microscope for positron lifetime studies with enhanced lateral resolution in the micro meter range (cooperation of the UniBW and TUM).

- **Open beamport:** A multi-purpose beamport allows various experimental set-ups to be connected to the positron beamline. At present, an apparatus (developed at the University of Trento) for the production of cold Positronium – a bound state of an electron and a positron – is in operation in order to study the material and temperature dependent production rate of this purely leptonic system.

Funding of the projects by the DFG within the Transregional Collaborative Research Center TRR80 and by the BMBF (project no. 05K10WOB) is gratefully acknowledged.

*C. Hugenschmidt (FRM II)*

### References

- [1] C Hugenschmidt et al 2013 J. Phys.: Conf. Ser. 443 012079 doi:10.1088/1742-6596/443/1/012079.
- [2] C. Piochacz et al.: Appl. Surf. Sci. 255 (2008) 98.
- [3] C. Hugenschmidt et al.: New J. Phys., 14 (2012) 055027.

## PGAA Going Digital

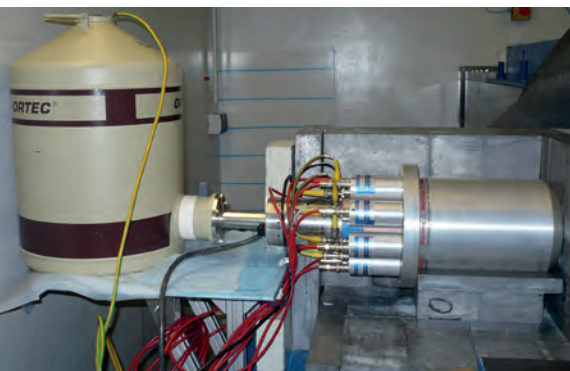

Fig 1: Ortec HPGe detector introduced into the BGO scintillator annulus.

The introduction of digital signal processing is not new in detection technique. However, it has started propagating in our field just very recently. We have waited for this break-through for about two decades, and after the first disappointments, we start to be satisfied.

Our instrument consisted of the following units: The most important part of the spectrometer is a high-purity germanium (HPGe) detector, which detects the gamma radiation emitted by the sample. This detector needs a high voltage of -4500 V for its operation. In the old analog system it had its special power supply unit among the electronic modules. The very weak signal from the detector has to be amplified by the so-called pre-amplifier, which is practically the part of the detector. In the simplest case, this pre-amplified signal is further amplified by the spectroscopy amplifier, then it has to be digitized by the **Analog-to-Digital Converter (ADC)** and then acquired by the **MultiChannel Analyzer (MCA)**. All these different analogue modules can now be replaced by one digital spectrometer, in our case the Ortec DSPec 50.

Besides the digital handling of the energy signal, we still use analog modules for the so-called Compton suppression. A bismuth germanate (BGO) scintillator annulus surrounds the HPGe crystal to collect the photons scattered out from it. Whenever the two detectors fire at the same time (within about 1  $\mu$ s), it means events that are not fully detected by the HPGe detector, and they have to be rejected (see fig. 1). The logical signal permitting or prohibiting the acquisition of the energy signal has to be connected to the "Gate" input, and the proper timing has to be set using the analog modules together with the digital spectrometer.

The digital signal processing is based on the application of digital filters on data streams. Digital filters have been used for many decades in spectroscopy, but the on-line calculation on data streams with the frequency of several hundred MHz has become possible just a couple of years ago. The simplest filter is the averaging that can be represented as a vector of constants: e.g. {1, 1, 1, 1, 1} means the calculation of  $X_i = X_i + X_{i+1} + X_{i+2} + X_{i+3} + X_{i+4}$ , i.e. the moving average multiplied by the factor of 5, while the {1, -1} is the differentiating filter calculating the derivative of the data stream from the differences of two neighboring channels.

In digital spectrometers, a combination of this two has been implemented: {1, 1, 1, ..., 1, 1, 0, 0, 0, ..., 0, -1, -1, ..., -1, -1}, which results in an averaging over several microseconds on both sides, and differentiating in the middle. The differentiation starts after a break, as in the channels multiplied by zero, no operation is made.

The signal from a transistor-reset preamplifier has a shape of a step function. When one applies the above filter to it, one gets a trapezoidal response. During the rise time, the average is being built up, during the flat top, no calculation is being made, during the fall time (which is normally taken equally long as the rise time), another moving average is being determined. The flat top is necessary for ignoring of the irregular shape of the jump in the signal. The rise and fall times are 6  $\mu$ s, while the flat top is 0.8  $\mu$ s in our case. When using the resistor-feedback preamplifier, the signal decays away after the jump following an exponential function with a given time constant. This has to be corrected for, which also can be done using a digital filter.

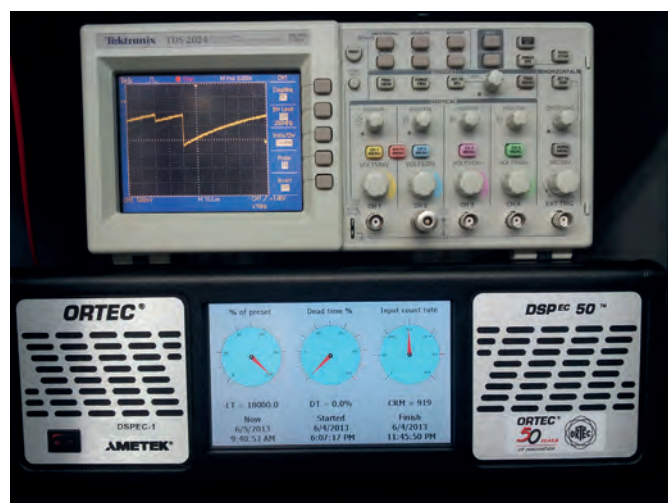

Fig. 2: The DSPec 50 unit with an oscilloscope showing the signal from the preamplifier.

Digital spectrometers provided by several manufacturers were found to be highly noise sensitive. In PGAA, we use relatively small gains for the signals, thus the noise picked up from the environment or the power line may appear to be of similar intensity as the lower-energy signals. This distorts the peaks, worsens the resolution, and may worsen the performance of the Compton suppression, too. Digital spectrometers have been used for many years in traditional neutron activation analysis with satisfactory performance. However, when used in instrumental halls (e.g. in a noisy environment), the analog electronics (NIM modules) produced much better resolutions and they were much less noise sensitive.

The new DSPec50 has passed our noise test very well, and other features also seemed very attracting. This unit performs all the above-mentioned calculations and many others. Fig. 2 shows the unit together with an oscillo-

scope. The signal displayed by the oscilloscope does not show an individual signal, but a pile-up, as the measurement was made with a high count rate. The spectrometer can handle pile-ups even below 20  $\mu\text{s}$ . The acquisition software contains a so-called “in-sight” mode to be used for checking the filter, the acquisition, or the gated signals. In case of the Compton suppression one needs to verify, if the gate overlaps with the flat top of the filtered signal, as it can be seen in fig. 3.

Ortec implemented many of its development in this model. The spectrometer can also be used with detectors equipped with mechanical coolers, i.e. ones with a compressor. The mechanical vibration disturbs the detector, and a low-frequency wave appears on the baseline below the signal. This low-frequency variation (from any other source, too) can be filtered out by a special filter: the trapezoid has two small negative trapezoids on both sides, which filter out the slow waving of the baseline. Later, we would like to equip at least one of our detectors with a mechanical cooler (X-cooler), we look forward to the application of this feature.

The so-called **Zero Dead Time (ZDT)** has been very popular among the analysts working with NAA. This option has to be chosen, when the count rate changes during the measurements. It corrects the spectrum for the lost counts continuously based on the special fast filters which detect signals arriving during the dead time. As in prompt gamma measurements the activities are practically constant, we do not use this feature.

Another important novelty of this spectrometer is the so-called list mode. Here, the acquired events are registered

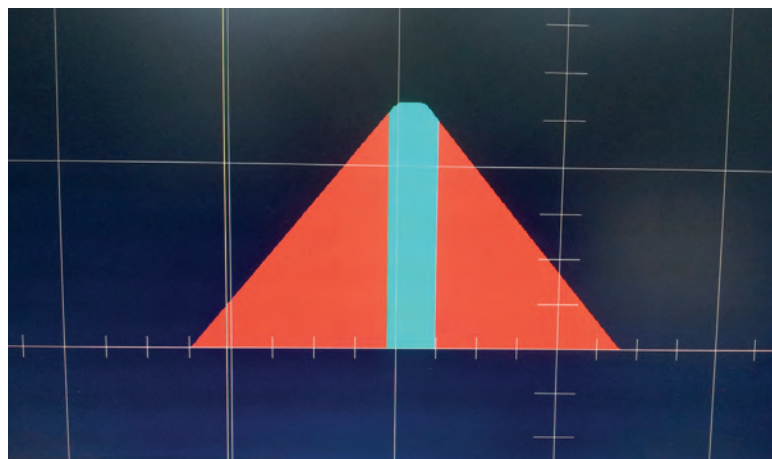

Fig. 3: The trapezoidal signal in the “in-sight” mode of the spectrometer as seen on a monitor.

as short records containing the time stamp and the energy of the signal. This is useful for following the time dynamics of experiments. At the moment, the time resolution is not yet enough for performing  $\gamma$ - $\gamma$ -coincidence measurements with two detectors, but we hope that a new version of the software will be capable of that.

The spectrometer proved to be very stable during the operation at PGAA measurements, produces spectra with a much better peak resolution than the earlier setup based on analog modules. It can also handle extremely high count-rates (up to 50,000 counts per second in Compton-suppressed mode, or even higher), further increasing the dynamic range of the instrument.

*Z. Revay, P. Kudejova (FRM II)*

## Switching Between Reflectometry and GISANS at MARIA

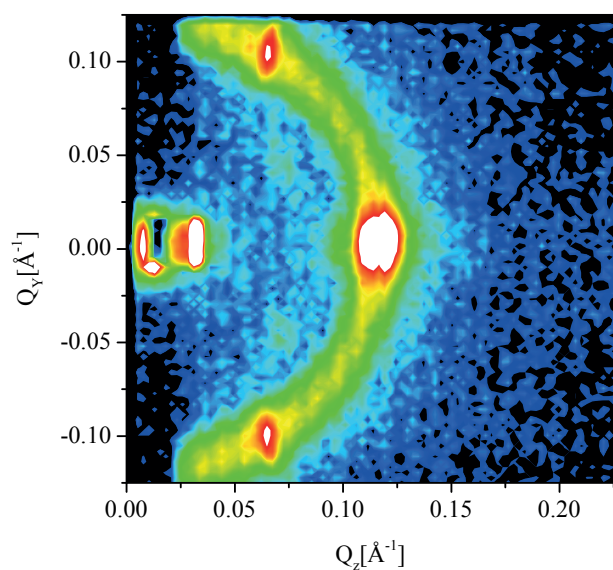

GISANS soft-matter measurement with 10  $\text{\AA}$  in 1200 s of  $\text{C}_{10}\text{E}_4$  +  $\text{Pep}_{15}\text{Peo}_5$  on a silicon surface in the hexagonal phase.

The high flux polarized neutron reflectometer MARIA (**MA**gnetism **R**eflectometer with high **I**ncident **A**ngle) of JCMS is optimised for the study of magnetic nanostructures, serving the rapidly growing field of spintronics or magnetoelectronics, i.e. information storage, transport and processing using the spin of the electrons. The instrument will offer unique features which are implemented and tested at the moment.

One thrilling feature of MARIA will be the capability to switch between the reflectometer mode with a vertically focussing beam on the sample and the GISANS/SANS mode with a pinhole geometry in seconds. The figure shows a measurement that was done with the heatable liquid cell, where the liquid/solid interface is probed on a polished and chemically prepared silicon block.

*S. Mattauch, A. Koutsoumpas, U. Rucker, E. Babcock, A. Ioffe Th. Brückel (JCMS)*

## MAUD – Materials Analysis using Diffraction

Garching, March 6<sup>th</sup>-7<sup>th</sup>



The workshop aimed to get MLZ scientists and users better acquainted with the possibilities of the software MAUD and to exchange applications and expert knowledge with the author, Luca Lutterotti from the University of Trento, Italy. It was jointly organised by Markus Hölzel (Technische Universität München) and Wolfgang Schmahl (Ludwig-Maximilians-Universität München). A particular intention of the workshop was to support materials science projects related to the diffractometers SPODI, STRESS-SPEC, POWTEX, and BIODIFF which benefit from the peculiar capabilities of MAUD.

MAUD stands for **M**aterial **A**nalysis **U**sing **D**iffraction and is a general diffraction/ reflectivity analysis program written by Luca Lutterotti. The program MAUD applies the Rietveld method to illuminate at the same time atomic arrangements in materials, preferred orientation of crystallites (texture), stress-/ strain-states between and within crystallites or other microstructural properties. According to Luca Lutterotti, he encountered problems to analyze diffraction data from thin films caused by coherence stress in these materials when staying at the University of California at Berkeley (USA) as a visiting scholar in 1991. There, the first idea came up to perform structural analysis combined with stress analysis from one data set in a dedicated data analysis code.

It took six months from the idea to get the first version released. MAUD's philosophy is to provide a kind of framework to help scientists to analyse most of the diffraction data files convenient for the Rietveld analysis method. In 1999 Luca Lutterotti gained a European grant within the Fifth Framework Programme. From then on several laboratories worked together, in particular the University of Trento, Laboratorio MDM in Agrate Brianza, both Italy, and the Institute Laue-Langevin in Grenoble, France. Ad-

ditionally, they could persuade the company ST Microelectronic near Milano, Italy, to support their project. Thus, the grant was a real booster because many people worked on the extension and improvement of the program. Since 2000 the number of beamline facilities dealing with area detectors has increased significantly and rapidly. So there were a lot of area detectors data waiting to be analysed for their complete information content, and MAUD was adapted to work with the corresponding diffraction images.

Currently, Luca Lutterotti wants MAUD to be extended to work with new instruments with a strong focus on materials science analysis rather than on classical crystallographic structure analysis. The ambition is to make it an outstanding tool for materials scientists.

Some projects arising at MLZ and/ or collaborating institutes using MAUD are:

- the mechanical anisotropy of shape memory alloys under mechanical stress;
- technical ferroelectrics under the influence of electric fields to study the poling mechanisms, i.e. domain switching, structural phase transformations and field-induced strain;
- geologic deformation processes and the concomitant preferred orientation changes of crystallites during pressure and/ or temperature treatments;
- texture and phase analysis of engineering alloys (steels, cast iron...) in particular under the influence of mechanical stress and high temperatures.

In Luca Lutterotti's opinion, MAUD has to reach two goals. In the first instance, he wants to combine the analysis of the material's structure with its strain state and the preferred orientation of the crystallites. Everything should be integrated: experimental setup, collection of data, understanding of its characteristics and final analysis. The second aim is the parallel development of the design of a new instrument and the MAUD data analysis software to cope with the challenges simultaneously in the future.

Luca Lutterotti emphasized his pleasure having the exchange with all the high level specialists from MLZ and hopes for a mutual benefit concerning the powerful program MAUD. Further information about the software package can be found at [www.ing.unitn.it/~maud/](http://www.ing.unitn.it/~maud/).

*M. Hölzel (FRM II)*

## DPG Spring Meeting

Regensburg, March 10<sup>th</sup>-15<sup>th</sup>

In March, the Deutsche Physikalische Gesellschaft (DPG) invited all its members and other interested scientists for the Spring Meeting of the Condensed Matter Section to the beautiful World Heritage Site Regensburg. 5161 participants accepted the invitation and gave or listened to 2982 talks and discussed lively in front of 1644 posters in total. Hence, it can be rightly described as the biggest physicists' meeting in Europe. As expected, most of them came from German institutions but more than 10% were visitors from other EU countries, USA and Canada, Asia (Japan in the first place) and further countries.

One highlight was the talk of the 2010 noble prize winner, André Geim (The University of Manchester), about Graphene, the new fascinating material with lots of possible applications.

Besides the scientific programme there is always an industrial and books exhibition at the Spring Meetings. For the first time, the MLZ could present itself with a big booth there. Many questions were asked by interested students and scientists. Many of them have not used neutrons or positrons

for their research until now and thus they were really surprised when they learned how they could benefit from experiments at the MLZ.

The User Office team was happy to inform them how to get beam time - and it looks forward to receive many proposals from first time users for the upcoming round!

*I. Lommatzsch (FRM II)*



## Workshop on Grazing Incidence Scattering Software

Garching, April 9<sup>th</sup>-10<sup>th</sup>

In April, the MLZ campus in Garching welcomed around thirty scientists for a workshop on grazing incidence scattering software. The goal of this meeting was to bring together experts in this field to discuss theoretical and experimental challenges as well as the available software tools for modelling and analysis of the data.

The difficulty of interpreting and analyzing **G**razing **I**ncidence **S**mall **A**ngle **S**cattering (GISAS) data formed a

recurring theme during a handful of presentations and the lively discussions that followed them. Part of the presentations elaborated on the theoretical and practical challenges of GISAS experiments, while the other part was centered around the available software tools to leverage these difficulties. The organizers, the Scientific Computing Group of MLZ, took the opportunity of announcing publicly their own software project for GISAS, called BornAgain.



The discussions made clear that there still exists a gap between the current scientific work and the tools to process the resulting data. However, the different backgrounds of the participants increased our understanding of the current and future needs for software tools. In this way, a clearer view has emerged on how to proceed further in this interesting and expanding field.

*W. Van Herck (JCNS)*

## Rotatable Multifunctional Load Frames

### Materials Analysis under Mechanical Load

The development and improvement of engineering materials requires the understanding of the relationships between the structure and materials properties. In-situ neutron diffraction under mechanical load offers the possibility to follow structural changes on an atomistic level in connection with mechanical behaviour. In particular such investigations are typically carried out to study stress-induced phase transformations and texture developments or to derive the diffraction elastic constants. Novel tensile rigs were developed at the Heinz Maier-Leibnitz Zentrum for their application at the materials science diffractometer STRESS-SPEC and the high-resolution powder diffractometer SPODI, as both instruments offer complementary capabilities for materials' characterisation.

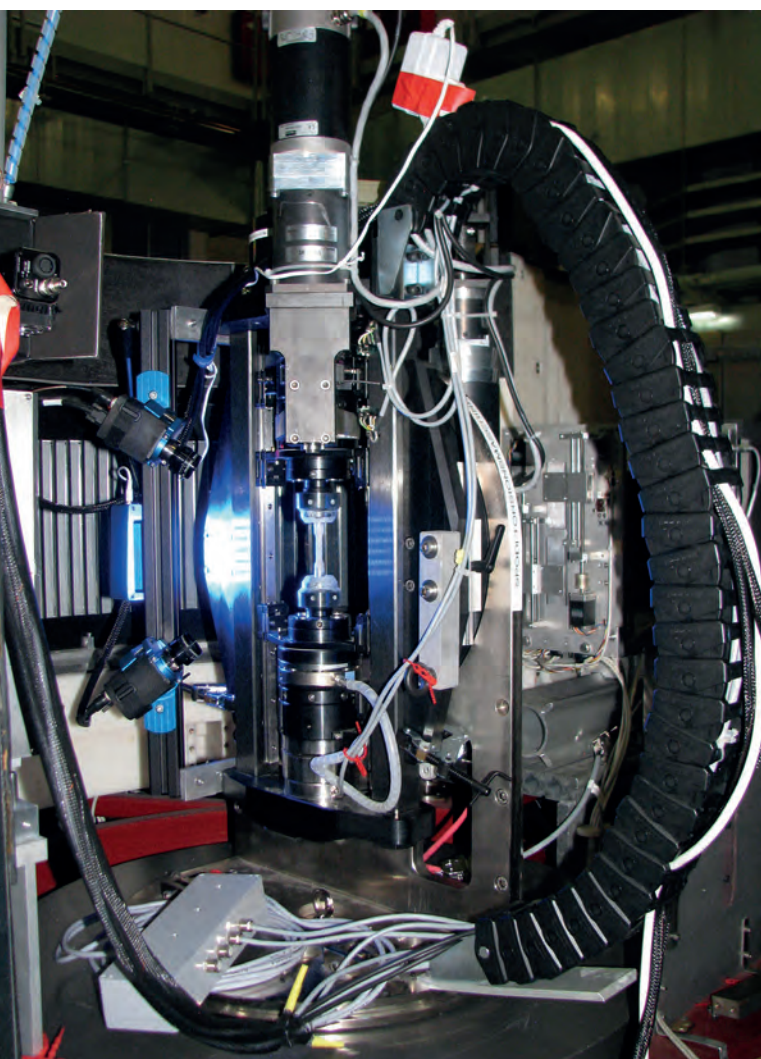

Fig. 1: Multiaxial load frame equipped with cameras for optical deformation analysis at high-resolution diffractometer SPODI.

The load frames allow a unique Eulerian cradle type orientation of the load axis with respect to the incident beam. In this way, the load axis can be moved by a  $\chi$ -rotation around  $90^\circ$  from a horizontal to a vertical setup. A maximum load of 50 kN can be applied for tensile or

compressive load. Based on this design principle, two versions have been constructed. One rig ("uniaxial rig") offers uniaxial tension and compression and is optimised for texture analysis (e.g. pole figure measurements) by a free sample rotation around the  $\varphi$ -axis. This novel design concept using a rotating frame enables to derive complete pole figures under strain. The usage of conventional double column tensile rigs on goniometers has the disadvantage that by  $\varphi$ -rotation the columns of the load frames move through the incident and the scattered beam, resulting in incomplete pole figures. The second rig ("multiaxial rig") enables in addition to tension/compression the application of torsion up to 100 Nm. The load frames were designed by Philipp Jüttner (engineering department at FRM II) and manufactured at the mechanical workshop at Department of Physics of Technische Universität München. Günther Seidl (technician at the instruments STRESS-SPEC and RESI) developed the layout of the electronic components.

The load frames are controlled by electronics and software purchased from DOLI company. A common interface to the control software of the diffractometers SPODI and STRESS-SPEC was developed in house (Christian Randau, now Universität Göttingen). Thus, the tensile rigs can be operated under remote control at both instruments. The axes for  $\chi$ - and  $\varphi$ -rotation are integrated into the control software of the instruments. Together with the rotation of the main sample table ( $\omega$ -axis) the sample can be oriented with respect to the incident beam by an Eulerian cradle like movement. Target values for load, torsion, sample extension (i.e. "strain"), the position of the crossbar or the torsion angle can also be set by the instrument control software. Experiments can be carried out either under load control, position control or strain control mode.

Grips for tension and compression experiments were designed for standard samples referring to DIN 50125. The specimens shape can be round with maximum diameter of 10 mm or rectangular with a maximum width of 6 mm depending on the material. At SPODI, in general round samples are investigated. For torsion experiments a modified sample geometry based on round standard samples was developed to avoid slip of the sample under torque. The macroscopic strain is usually measured by clip-on extensometers. Recently, a camera based system (LIMESS company), provided by Wolfgang Schmahl (Ludwig-Maximilians-Universität München), was set into operation to enable a contact-free recording of the extension. It was applied to monitor the extension in a load controlled experiment at diffractometer SPODI (fig. 1). In that manner, larger sample volumes can be investigated compared to the usage of clip-on extensometers. A detailed description of the specifications of both tensile rigs and their applications is given in reference [1].

A few experimental examples are given in the following

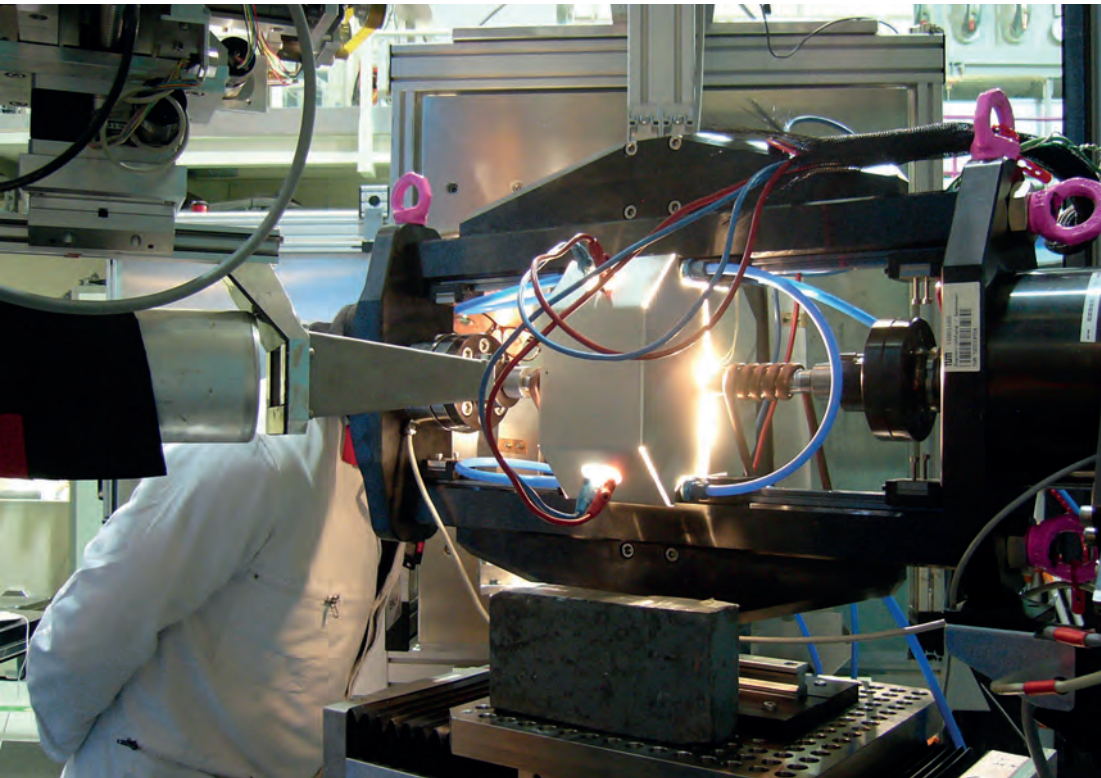

Fig. 2: Mirror furnace on the uniaxial tensile rig at materials science diffractometer STRESS-SPEC.

to highlight the use and capabilities of the rigs at FRM II. Nickel based superalloys are used in high temperature applications like gas turbines. In order to study mechanical properties in relation to the microstructure at operating temperatures, a set of samples of the nickel base superalloy IN 718 were investigated at STRESS-SPEC

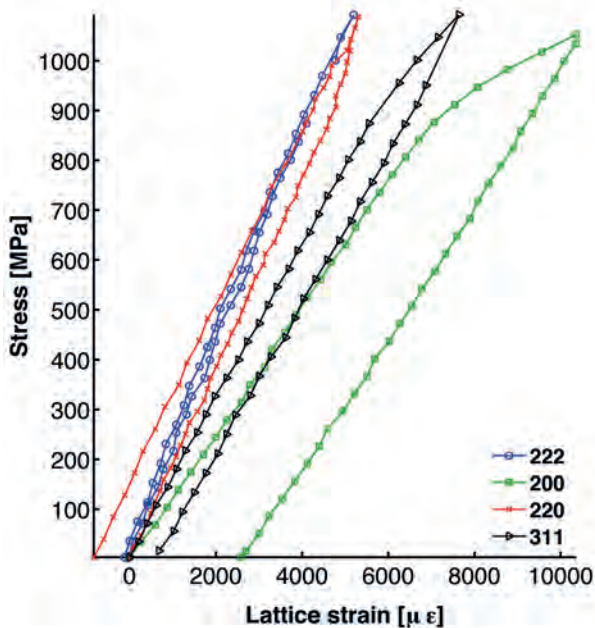

Fig. 3: Stress-lattice strain curve of several Bragg reflections of IN718 at  $T = 550^{\circ}\text{C}$ . The yield point (onset of plastification) is at about  $\sigma_{\text{makro}} = 900 \text{ MPa}$ .

under load and elevated temperatures. Fig. 2 shows the tensile rig setup for this experiment with a mirror furnace, which can heat samples to temperatures up to  $1000^{\circ}\text{C}$ . The experiments on IN 718 clearly show the development of intergranular microstrains at the onset of plastification above an applied macroscopic stress of about 900 MPa at  $T = 550^{\circ}\text{C}$  (see for one typical example fig. 3). The results from the tests of the complete sample set indicate that the interaction of the  $\gamma'$  and  $\gamma''$  precipitates will change the load sharing mechanism in these type of multiphase nickel superalloys [2]. In addition the data were also used to evaluate the high temperature dif-

fraction elastic constants. The anisotropy of the material response to the load is discernable in the varying slopes of the stress-strain curves of different Bragg reflections. The elastic anisotropy in monoclinic nickel-titanium shape memory alloys was studied at SPODI under various orientations (addressing  $\chi$ - and  $\omega$ -axes). The elastic constants have been derived using the formalism of Popa [3]. Investigations up to the pseudoplastic region allowed to separate the contributions to the macroscopic strain, namely ferroelastic twin switching, and elastic strain. It was found that a pure elastic response occurs only up to about 0.2% strain. The texture evolution by twin switching in these nickel-titanium alloys was investigated in more detail at STRESS-SPEC. Complete pole figures obtained at different strain levels revealed a fibre texture. The data will enable us to calculate the complete **O**rientation **D**istribution **F**unction (ODF) for the monoclinic martensite phase.

The design has already been proved so successful, that two rigs were designed and built for two other neutron scattering facilities (Chalk River Laboratories, Canada, and Helmholtz-Zentrum Berlin).

*M. Hölzel, M. Hofmann (FRM II)*

## References

- [1] Hoelzel et al, Nucl. Instr. A 711, 101-105 (2013).
- [2] Repper et al, Appl. Phys. A 99, 565-569 (2010).
- [3] Popa et al, J. Appl. Cryst, 33 (2000), 103-107.

## Casting and In-situ Neutron Diffraction

Residual stresses in castings are a result of temperature changes or differences during cooling. Especially composite castings like a motor block with in-cast cylinder liners [1] exhibit significant residual stresses. The cylinder liners – also termed as insert – are commonly made of cast iron and are located in the aluminum casting. This compound shows internal stresses after casting due to different thermal expansion coefficients of the iron based insert and the aluminum surrounding as they differ significantly. The knowledge about residual stresses is essential to avoid distortions for example and to utilize materials potentials. Therefore this has to be taken into account already in the design stage of a part. This is usually done by numerical simulation but recent investigations within the framework of a DFG funded research project of FRM II together with the Institute of Metal Forming and Casting (utg, TUM) have shown large deviations between cal-

culated stresses from numerical simulations and measurements. The deviation was attributed to unaccounted relaxation effects during the build-up of stresses in the cast while cooling [2].

To investigate this in detail an experiment was recently devised, where the build-up of strains during the casting process could be monitored in-situ using the neutron diffractometer STRESS-SPEC. For the experiments a composite specimen was used, consisting of a steel insert with a cast aluminum surrounding to model the conditions of motor block components. The design ensured on one hand the occurrence of high residual stresses which are significantly higher than the uncertainties from standard diffraction measurements. On the other hand the principle strain directions could directly be inferred by the geometry as the specimen is axially symmetric.

Fig. 1: The experiment started with careful alignment of the mould including the steel insert on the diffractometer and instrumenting the sample with thermocouples to monitor the temperature at the selected position in detail during cooling.

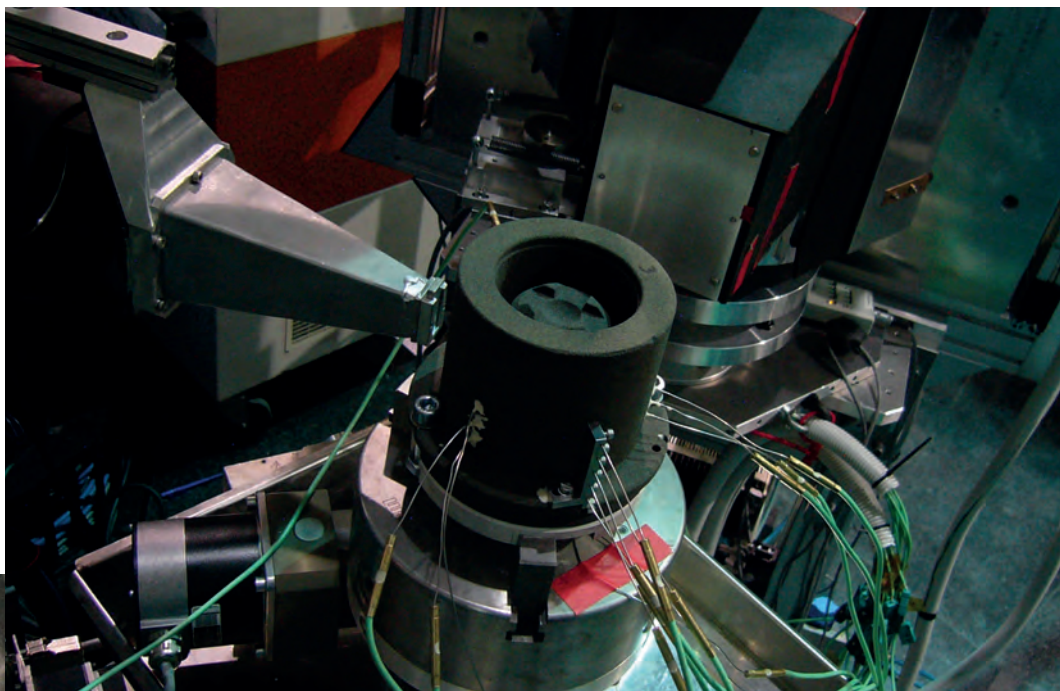

Fig. 2: The next step was heating Al in a melting furnace to casting temperatures of about 700°C.



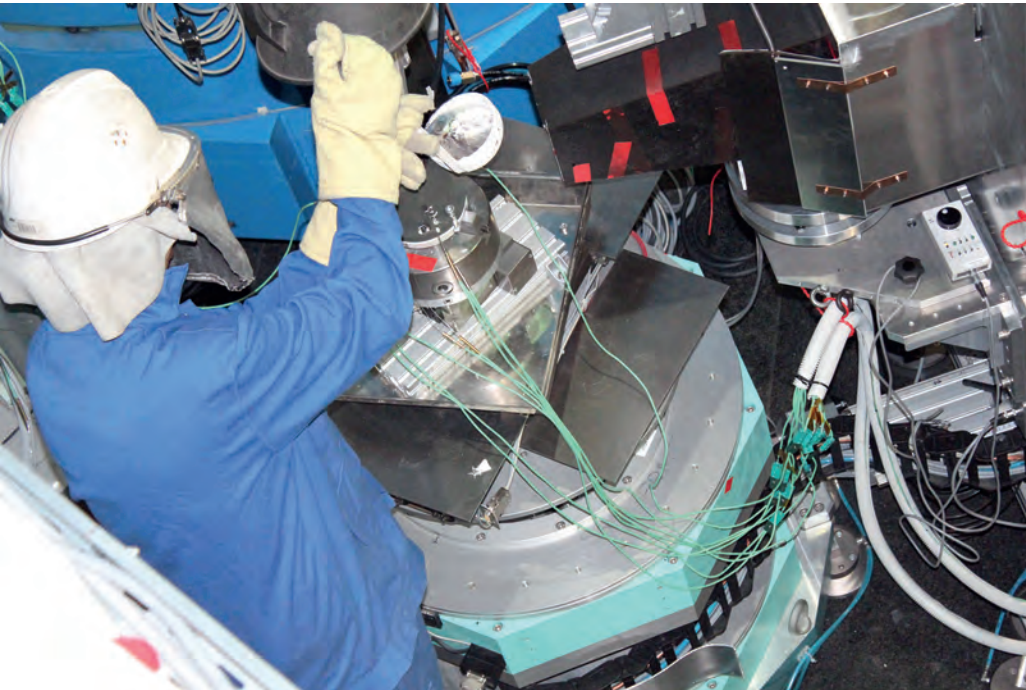

Fig. 4: Immediately after that the experimental team left the experimental area and opened the shutter of STRESS-SPEC to start the neutron measurement in order to record the strain evolution during solidification and cooling of the aluminium until room temperature.

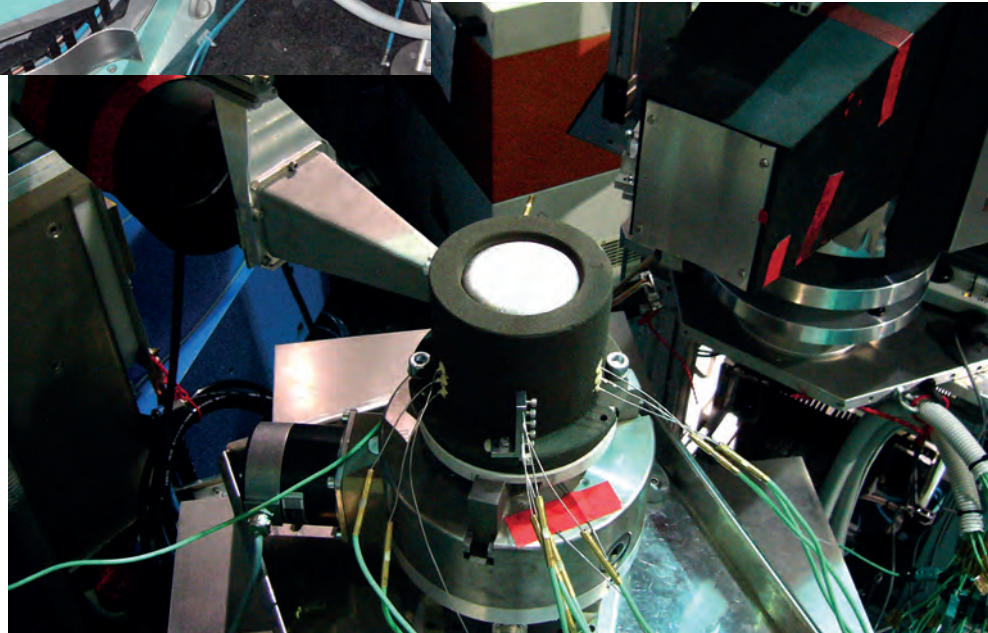

Fig. 3: Afterwards, the molten aluminium was poured with a scoop into the mould.

For each individual strain direction (e.g. hoop or radial in steel or aluminium) one casting experiment had to be performed. The results showed that at temperatures higher than 400°C no mechanical strain exists. Mechanical strains start to develop at about 350°C followed by an almost linear progression down to 150°C. Below 150°C no further increase in the strain evolution is observed. This is due to the exceeding of the limit of elasticity in the aluminum cast, which is responsible for the build-up of mechanical strain in the steel insert in the composite specimen. The results were presented at the International Conference on Residual Stress in October 2012 [3] and a further publication is in preparation, where the results of the in-situ measurements will be incorporated in optimized simulation models of the casting process.

*M. Hofmann (FRM II)*

*M. Reihle (utg)*

## References

- [1] S. Beer et al., Aluminium Motorblöcke, Bibliothek der Technik, no. 278, Moderne Industrie, München, 2005.
- [2] U. Wasmuth, Orts- und zeitabhängige Analyse von Eigenspannungen in Verbundguss, Ph.D. thesis, Technische Universität München, Hieronymus, München, 2009, ISBN 978-3-89791-400.
- [3] M. Reihle et al., Proceedings of ICRS9 (2013), in print.

## NMI3: European Research in Garching

Started already within FP6, the **N**eutron scattering and **M**uon spectroscopy **I**ntegrated **I**nfrasturcture **I**nitiative (NMI3) joins European activities of large scale facilities and research institutes in these fields. Today, 18 partners in twelve countries provide scientists' access to nationally funded neutron and muon sources in Europe. The FRM II is one of the most frequented sources and provides more than 350 days of beam time yearly for this project. NMI3 consists of three columns: the access programme, the **J**oint **R**esearch **A**ctivities (JRA), and networking including management. The JRA part aims to develop methods and components to improve the service and research opportunities for its users. The NMI3-I project ended in January 2013 and this overview focuses on the MLZ contributions, which are divided in several work packages starting with

### Detectors

Present state of the art detectors are based on either the electrical charge generated or the emitted light from the absorption process. Based on the gaseous scintillation proportional counters scientists from the FRM II participate in the development of a new family of detectors. The main challenges are investigating a new detection process, developing adequate readout electronics, and demonstrating the feasibility of this detector within a 20 x 20 cm<sup>2</sup> active area. The detector group has built three identical small-sized GSPC chambers and distributed them to Forschungszentrum Jülich and ISIS. They studied different light readout schemes and the possible use of a modern GPU as NVIDIA GeForce GTX570 for an online reconstruction algorithm. The comparison of simulated data with experimental data is promising: *“Our technology could enable the design of neutron counting detectors with superior performance that exhibit a high*

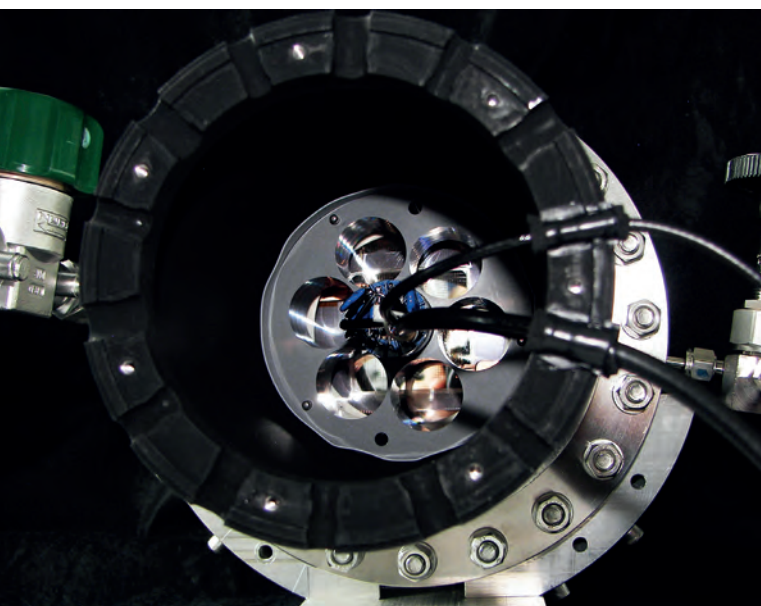

Fig. 1: One of the newly developed detectors at MLZ.

*count rate capability of up to 10 MHz, a high spatial resolution (~1 mm) and low gamma sensitivity on a par with gaseous detectors.”* says project leader Karl Zeitelhack (FRM II). The Monte Carlo simulation package ANTs allows to optimise the detector design and to predict and understand its performance as well as to analyze the experimental data of a GSPC with elaborate algorithms.

### Deuteration

A new method of deuteration, developed at the TUM, now allows contrast matching studies on a far wider range of sample systems. The scientists developed a guideline and recommendation for all neutron researchers and established two model systems for implementing and optimising protein ligation techniques. They subsequently demonstrated the expression of fragments and the ligation using protein trans-splicing techniques. The purified protein was used for SANS measurements with contrast variations at ILL in order to document the use of segmental deuteration. This result will extend the range of tackled problems and reduce the cost of sample preparation. The **N**uclear **M**agnetic **R**esonance (NMR) community also increasingly uses neutron scattering and urgently needs isotope labelling.

Fig. 2: Suitable biomass systems are highly interesting for deuteration.

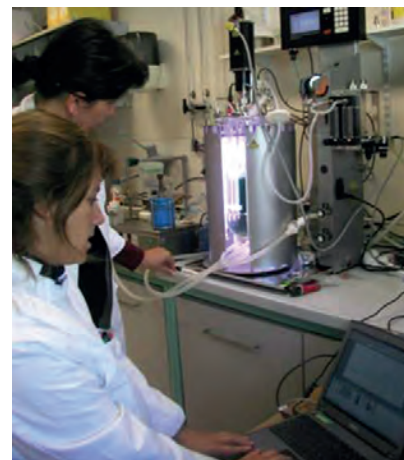

### Neutron Optics

The work at MLZ was focused on two main objectives: High flux reflectometry and **S**mall-**A**ngle **N**eutron **S**cattering (SANS), focusing cold neutrons included. Recently researchers succeeded in implementing high performance supermirrors into optical devices: trumpet guides, ballistic guides, polarizing benders etc. and thus improving existing spectrometers. Advanced numerical simulations and upgraded Monte Carlo programs were necessary to improve the refractive and focusing optics and to adjust them precisely for example to be used in connection with extreme sample environments. The developing scientists integrated their new and better lenses and elliptic neutron guides in the KWS-1 and the TOFTOF instrument at the MLZ, respectively. They built and tested two prototypes of full scale, adjustable focusing devices

and the results completely agree with the numerical simulations. Frédéric Ott (LLB/CEA) summarizes: *“We could demonstrate several proofs of concepts and built a more advanced 2D focusing device for the TOFTOF at FRM II with much better characteristics and four piezomotors with holders to tune the mirror’s curvature. On the TOFTOF instrument, this device allows changing the curvature of the supermirrors in order to keep the focal point at the sample position.”*

### Sample environment

Some time ago the German Aerospace Centre (DLR) developed an automatic control system for liquid samples in a high temperature environment. This technique was not optimised to be used for neutron scattering experiments, for example at the TOFTOF instrument at the FRM II. The main challenge was to adapt the electrostatic furnace to the spatial constraints given by a neutron scattering instrument. The system also needed an upgrade to levitate larger samples required for the neutron experiments. Together with the DLR, the team constructed and tested a containerless furnace and used it for neutron scattering experiments on beamlines at both FRM II and Institut Laue-Langevin (ILL). Team leader Jürgen Peters (FRM II) summarizes: *“The system fulfills all specifications, it is compact, can be loaded from above and can be moved from one instrument to another.”* The additional laser pre-heating stage removes unwanted organic material from the sur-

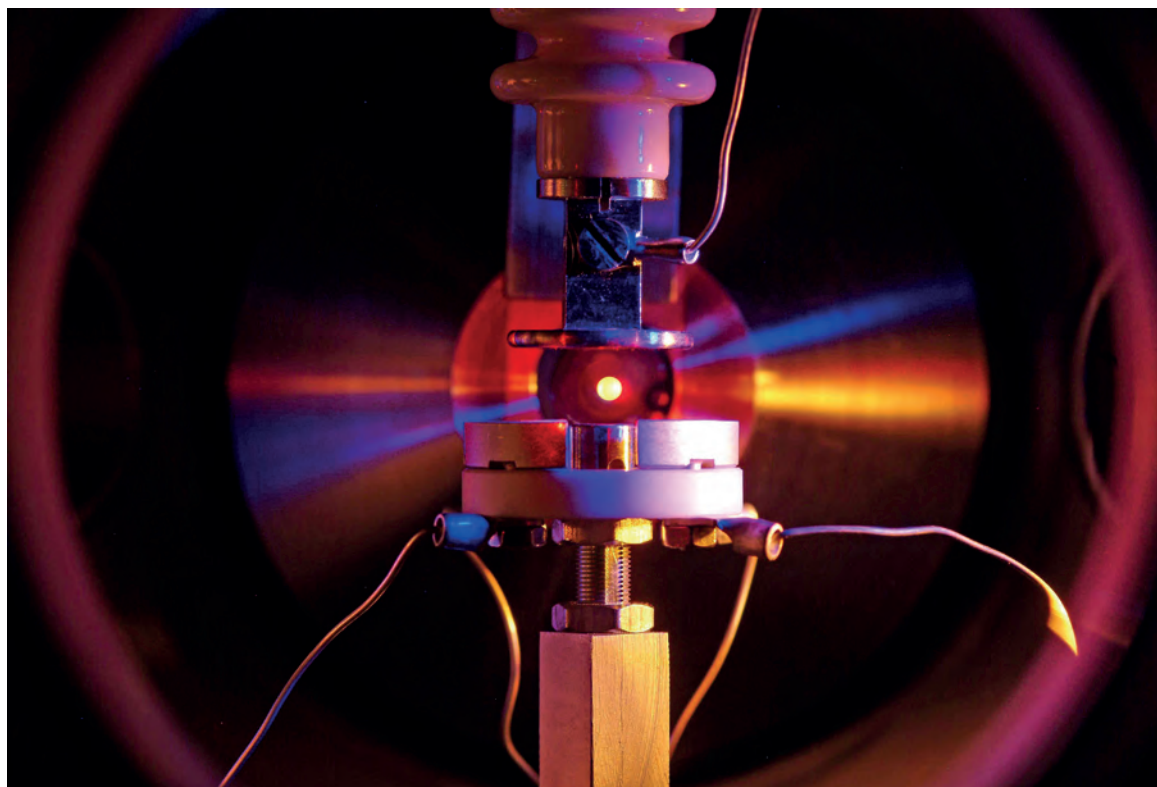

Fig. 3: A sample in levitation.

face of the sample as well as dissolved gases and other contamination off the bulk material. This results in a more reliable and faster melting process and aids the processing of new sample systems.

### Polarized Neutrons

Condensed matter research depends on highly efficient neutron diffraction and spectroscopy techniques, so an easily accessible wide-angle polarisation analysis technique with higher energy and momentum resolution was an urgent wish. The team of Alexander Ioffe (JCMS) could develop a new design and produce a complete set of the so called “Pythagoras-coils”, which are large solid angle coils, for the spin-echo spectrometer J-NSE at the MLZ. Therefore, they further improve the resolution and the transmission of neutron-spin echo spectrometers. Moreover the FRM II team also participated in the further development of the MIEZE technique, which widens the range of accessible samples up to highly depolarizing samples as ferromagnets.

Despite the fact that the researchers had to get over a painfully shortened budget this first funding period within the FP7 was very successful. The scientists of the NMI3 project therefore could convince the EU to fund a second project in FP7. Thanks to this, projects can go on and new ones can be started. For further and more detailed information have a look at [nmi3.eu](http://nmi3.eu)!

C. Kortenbruck (FRM II)

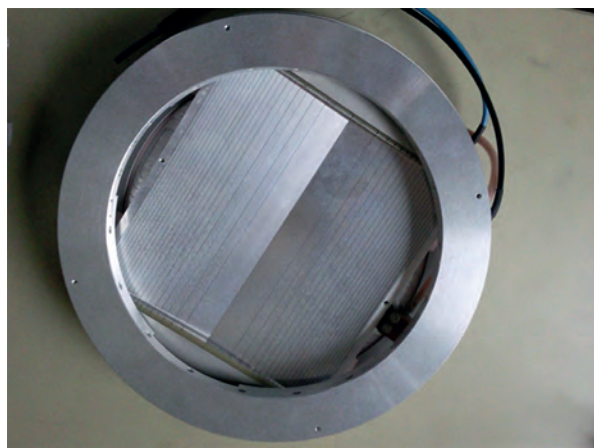

Fig. 4: One of the new Pythagoras-coils for J-NSE.

## In-situ Experiments for Texture Analysis

### Sample Environments for Deformation, Recrystallisation and Stress Analysis at POWTEX

Texture analysis has become a vital tool in geo- and materials science. While texture analysis in materials science is mainly used to optimise mechanical properties of technical materials, it is widely used in geoscience to reconstruct

- rock deformation processes,
  - lava flow kinematics,
  - recrystallisation and annealing processes,
  - biomineralisation and -crystallisation,
- all in different scales.

For studies of earth (crust to core) processes, technical applications of geomaterials and rock conservation projects (rock mechanics), texture analysis is used to calculate the physical properties of the equivalent rocks. Different national and international labs therefore use experimental apparatus to gain insight in the above mentioned geoscientific cases. As these experiments are not performed in-situ, questions about the time-resolved development of the prevailing processes are still mainly unsolved. Therefore, our working group started to devel-

Fig. 1: Deformation apparatus with horizontal spindle drive (red) and a triaxial cell between the pistons. The above inlay shows the apparatus inside the POWTEX detector. It is rotatable around the vertical axis to improve pole figure coverage. The sample is kept centric during the deformation experiments.

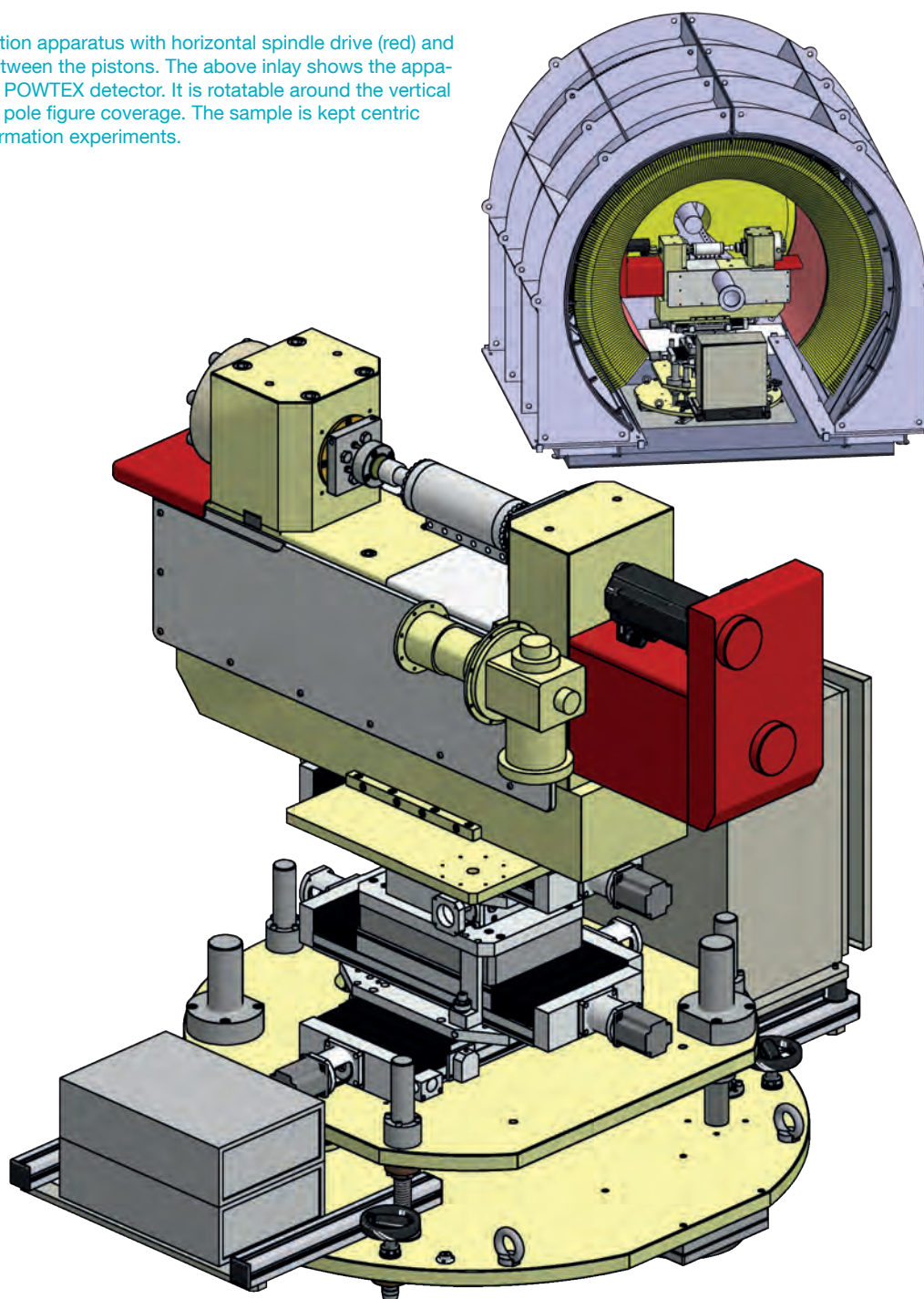

op sample environments for in-situ experiments at the new POWTEX (**POW**der and **TEX**ture) diffractometer at FRM II, because neutron diffraction is the only method which allows bulk texture analysis of several cm<sup>3</sup> sample volumes.

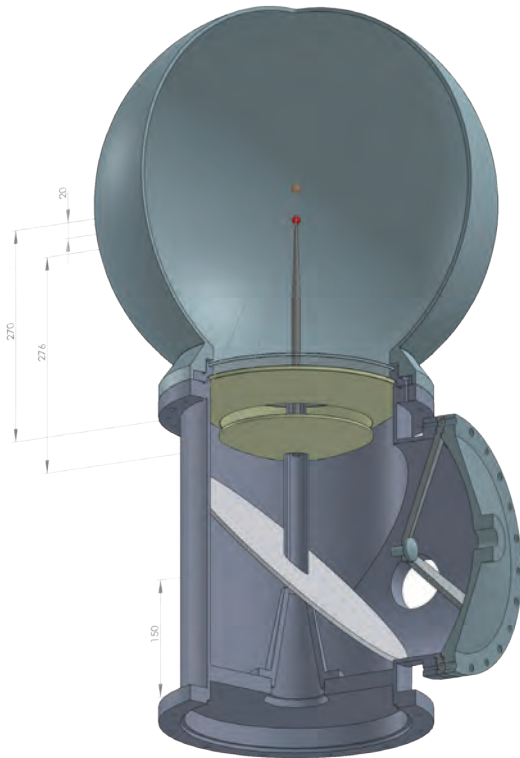

Fig. 2: Rotatable recrystallisation furnace with lens system for homogeneous sample heating by a (pulsed) laser. The furnace can either be evacuated or used as 'flow-through' furnace for different noble gas atmospheres. Construction and image by Herbert Weiss, FRM II, Garching bei München.

POWTEX is especially suitable for texture analysis with large sample environments due to the utilisation of the time-of-flight (TOF) technique, the optimisation to high flux ( $\sim 1 \times 10^7$  n/cm<sup>2</sup>s) and the high cylindrical detector coverage of about 9.8 sr. Short measuring times and sufficient polar sphere coverage with a few sample rotations allow time-resolved texture measurements in reasonable beam times. The largest sample environment is the uniaxial deformation apparatus (fig. 1), which is equipped with a spindle drive of up to 200 kN load force. This set-up allows compressive uniaxial and triaxial deformation experiments as well as simultaneous stress and texture measurements in tensile mode. Thereby, a maximum principle stress of 630 MPa is possible for a standard sample cylinder of 20 x 40 mm (d x l) with a confining pressure of 50 MPa. Experiments can be performed with strain rates between  $10^{-8}$  and  $10^{-3}$  s<sup>-1</sup> at temperatures either up to 1200°C or cooled down to 77 K. By the utilisation of triaxial cells, both pure and simple shear deformation modes can be investigated. This apparatus is

constructed to be rotatable around the vertical (z-)axis to increase pole figure coverage during the measurements. Furthermore, the apparatus is designed to keep the sample constantly in the centre of the beam during ongoing deformation. By the time-resolved measurement of the texture development in dependency of temperature and strain rate, the different deformation mechanisms, activation of glide planes in different deformation regimes can be studied in detail.

The second sample environment for texture analysis is a recrystallisation furnace (fig. 2) for the study of static recrystallisation/ annealing processes in materials. This furnace is revolving and can be used either in vacuum conditions or in 'flow-through' noble gas atmospheres. For recrystallisation analysis we perform in-situ texture analysis for every rotation. In a second step we recalculate the textural information by orientation stereology to a 3d information about the crystallographically controlled grain-growth or annealing processes as a function of the applied temperature. An example is shown in fig. 3. The furnace is heated by a combined laser and lens system for homogeneous sample heating of up to 1800° C, where its spherical part is only used as mirror plane to reduce secondary neutron scattering from the heating system as much as possible. The furnace was developed in cooperation with the sample environment group of the FRM II, where the construction and assembly of the furnace is performed, too.

*J. Walter (Geowissenschaftliches Zentrum der Universität Göttingen)*

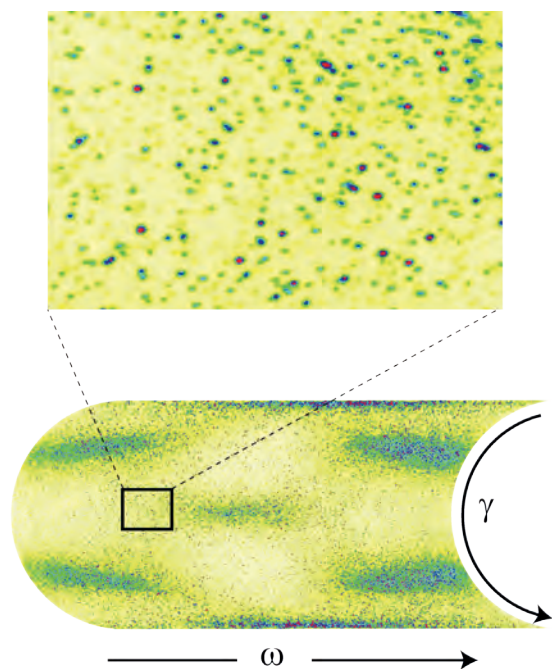
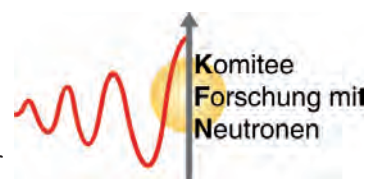

Fig. 3: Orientation stereologic recalculation of recrystallised steel textures from synchrotron measurements by Helmut Klein, Geowissenschaftliches Zentrum der Universität Göttingen.

## The German Neutron Community is Strong and Young!

The KFN does not get tired to demand a rapid and strong German commitment for the ESS. In a world confronted with scientific challenges related to urgent public tasks such as the transition to alternative energy resources and electromobility the need of a hydrogen sensitive probe which can deeply penetrate into matter is obvious. Of course, there are many other fields in which neutrons will substantially contribute to solve demanding scientific questions. The ESS with its unique performance will make experiments possible that can only be dreamed of today. On request of the BMBF the KFN is currently working on a short overview of substantial future contributions that can be expected from research at the ESS.



Neutron research in Germany was, is, and also needs to be based in the future on national neutron sources. They are the fundament of Germany's contribution to international sources like ILL today and ESS in the future. In this context the KFN highly appreciates the foundation of the Heinz Maier-Leibnitz Zentrum as a national competence center for research with neutrons with a strong international outreach. We congratulate the participating partners namely the Technische Universität München and the Helmholtz centers HZG, HZB, and FZ Jülich for this important cooperation.

HZB currently operates 16 neutron instruments at its research reactor BER II, more than ever before. There has been a substantial effort to instrument upgrades which is still going on. The outcome is an instrument suite that includes several world class instruments for cutting edge experiments but also contributes to provide the basic needs for standard neutron experiments which are equally important to solve the scientific questions mentioned above.

I strongly regret, however, that it has been communicated by the management of the HZB that it will not invest in neutron scattering on long term. This would essentially weaken German research with neutrons. Having in mind that there is an obvious significant impact of neutron research to the solution of urgent scientific challenges, an important public interest in retaining neutron research capabilities must be stated. Respecting the former shut down of the research reactors in Jülich and Geesthacht, a phase-out of the HZB neutron activities would bring the provision of neutrons on a national level to a critical limit.

Consequently I strongly ask the neutron community to actively support the KFN in its engagement to find a solution for retaining the competence in neutron research and instrumentation at HZB and to compensate for the reduction of neutron beam time capacity that is to be expected in the future.

Currently more than 1100 users are registered at KFN as scientists active in the field of research with neutrons. In a still ongoing survey already nearly 50 % of these users replied and about 90% of them declared that neutron experiments at ESS will be important for their future research. This reflects the fact that the German neutron user community possesses a healthy age structure with a high number of young scientists which could be observed at the German conference for neutron scattering in the last year. A strong and rapid German commitment for the ESS would help to keep the German neutron community strong and young but further steps need to follow.



Tobias Unruh  
Chairman of the 9<sup>th</sup>  
Komitee Forschung mit Neutronen  
(KFN)  
Tobias.Unruh@fau.de

## Newly Arrived

I am a new PostDoc in the correlated electron systems group for DNS instrument. I completed my PhD which consists in the effects of disorder in iron-based superconductors in Paris at École Polytechnique. My research interests are magnetic correlations and fluctuations, disorder and vortex pinning mechanism in high-Tc superconductors.



**Sultan Demirdis**

+49 (0)89 289 10717

s.demirdis@fz-juelich.de

As a new postdoc I joined the local contacts' team of the three small angle scattering machines KWS-1 to -3. I did my thesis not far away: At the TUM I studied the behaviour of poly (2-oxazolines) in aqueous solution, thermoresponsive polymers and polymers in drug delivery. My fields of interest are soft matter (structure and dynamics), lipid films and surface proteins.



**Sebastain Jaksch**

+49 (0)89 289 11673

s.jaksch@fz-juelich.de

Recently, I joined the team at MARIA as an instrument scientist. Before, I worked on membrane channels, protein confinement and polymers on surfaces as a PostDoc at LLB, CEA Saclay and at SOLEIL. I am especially interested in applications of small angle scattering and reflectivity (neutrons & X-rays) in biophysics and physical chemistry.



**Alexandros Koutsioumpas**

+49 (0)89 289 11674

a.koutsioumpas@fz-juelich.de

I am a new instrument scientist at MIRA. After working at the MPI of Biochemistry on fluorescence in protein crystals and later doctorating in the UK in the field of spintronics involving epitaxial systems I became PostDoc at the Peter-Grünberg-Institute (Jülich) where I worked, among other topics, on magnetic core-shell nanoparticles. My special interests? Nanoparticles for biomedical applications, spintronic devices and sensors.



**Klaus Seemann**

+49 (0)89 289 14668

Klaus.Seemann@frm2.tum.de

## The Infrastructure Group

The newly formed Scientific Infrastructure Group supports the scientists at FRM II in instrument-specific engineering and inter-divisional projects, including project planning and coordination.

It is composed of Edina Aulenbacher (designer of the 3D planning guide), Heiner Blumenthal (hall foreman), Alexander Beimler (project engineer and responsible for cooling water system FAK40), Elbio Calzada (project engineer), Uwe Reinecke (project engineer and coordinator), and Herbert Reithmeier (head of the group).

A major task of the Infrastructure Group is the structural connection and the system integration of the new Neutron Guide Hall East. This includes the construction of the connecting building between the reactor building and the East Building, as well as of auxiliary devices (e.g. crane systems) and media supply (e.g. cooling water). Since all installations must comply with the legal requirements of the Atomic Energy Act, every task must be diligently planned and rigorously realised according to the operation guidelines. System integration of the neutron guide hall east is in need of collision-free planning to supply the start-up instrumentation with respect to the special needs of the experiments (e.g. concerning media supply or accessibility); for that, a 3D planning guide is in development.

The Infrastructure Group also provides technical consulting services as well as planning and realization of mechanical engineering tasks in order to support the scientific utilization. This includes e.g.

- The custom-tailored design for instrument-specific fitments (e.g. sample environment for ANTARES) or for shielding measures for the experimental field (e.g. instrument RESEDA).
  - Design, production and installation of beam line components (e.g. instrument shutter for PowTex, TOPAS, TRISP, SAPHIR) of the shielding against ionising radiation of the shared neutron guides between the reactor building and the Neutron Guide Hall East (for instruments MEPHISTO, PowTex, TOPAS, TRISP, SAPHIR).
  - Analysis and optimization of the present cooling water system FAK40 for the extended utilization later on by the instruments planned in neutron guide hall east
- Besides this the Infrastructure Group is engaged in waste management of activated instrument components, for which unrestricted clearance according to §29 StrlSchV is not achievable. In close cooperation with the instrument scientists and with the FRM II radiation protection department, we support and advice in documentation, in handling and in methods to achieve safe and legally compliant permanent storage.

*H. Reithmeier (FRM II)*

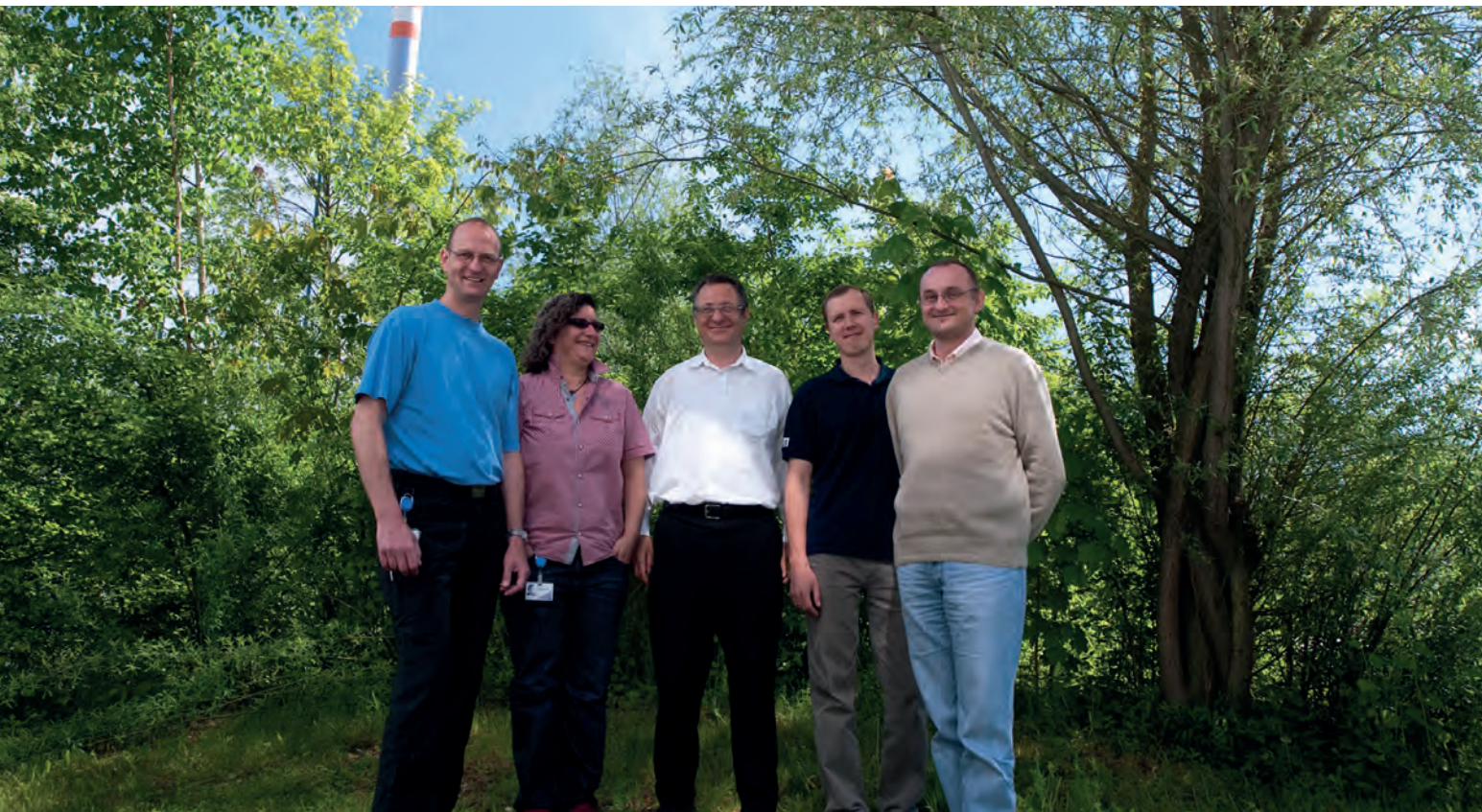

Nearly the whole team: Heiner Blumenthal, Edina Aulenbacher, Uwe Reinecke, Alexander Beimler and Herbert Reithmeier (from left to right).



## From Beijing to Munich: A Visiting Scientist at the MLZ



My name is Peng Cheng and I am staying at the MLZ for one year.

*You are a guest scientist from China. What is your scientific background and which are your special interests?*

I am a physicist and a university lecturer at the Renmin University of China in Beijing. In my PhD thesis I focused on Fe-based superconductors. Now I am especially interested in studying superconductivity with inelastic neutron scattering techniques.

*What are you doing at the MLZ?*

One of my major jobs here is to learn the operation and design of a three axes spectrometer because I am due to design and build a cold neutron three axes spectrometer (CNTAS) at the **China Advanced Research Reactor (CARR)** in Beijing. My yearlong stay at the Technische Universität München is based on the cooperation between the FRM II and the Renmin University. In the PANDA group together with other scientists of the MLZ, I work on preliminary designs and optimisation calculations of the planned CNTAS. I profit a lot from the experience of the scientists here, who have already designed and built the three axes spectrometers PANDA and PUMA, and them who are building KOMPASS.

*You are in Germany for the first time. What do you like most here?*

I like the people here. Especially the scientists and colleagues at the MLZ, they are all very kind and willing to help others. Besides, I like the climate here in Munich, it feels great to have a cool summer.

*Interview led by A. Voit (FRM II)*

## PR at the MLZ Reinforced!



Andrea Voit

We are now two persons in the Press and Public Relations Office: Andrea Voit is back from her maternity leave and Christine Kortenbruck is a new colleague since May 15<sup>th</sup>. Since 2008, Andrea has been representing the FRM II towards the public by press releases, webpages, events, and via journalists.

We will first focus on setting up new webpages for the FRM II and integrating them into the TUM Webpage. Our big aim is to present the large variety of scientific and industrial projects to the public.

Christine Kortenbruck



So please contact us, whenever you have an interesting result or a publication, which ideally even has some possible application.

### Press Office

**Andrea Voit**

+49 (0)89 289 12141

**Christine Kortenbruck**

+49 (0)89 289 13893

presse@frm2.tum.de

## MLZ Efforts for a Better Education and Training

Besides the scientific and industrial work the MLZ sets a high value in education and training and by this offers a wide range of educational activities. Young people start as an apprentice for different professions or as an undergraduate student of physics. Training is offered throughout the bachelor and master up to the PhD program and continues during the whole scientific career by seminars and workshops.

### Apprenticeships

Uwe Stiegel, leader of the mechanical workshop at the FRM II, explains: *“Our two apprentices stay with us for the whole three years of our German dual system of vocational training. This ensures a very good integration in the team and the best possible education and training.”* He points out that his two apprentices of mechatronics have – besides the great possibilities a university offers – quite unusual optional ones. This means for example a forklift license or a license for hoisting devices. They even may move for some weeks to the PSI in Switzerland or the ILL in Grenoble/France. Four more apprentices are trained at the MLZ in the area of information technology: two with the focus on application development and two with focus on system integration and network technology. They also very much appreciate education and training at the MLZ and coaching by AuTUM, the educational center of the TUM. The last apprentice finished as one of the best, worked a short time with an industrial company and returned to the MLZ!

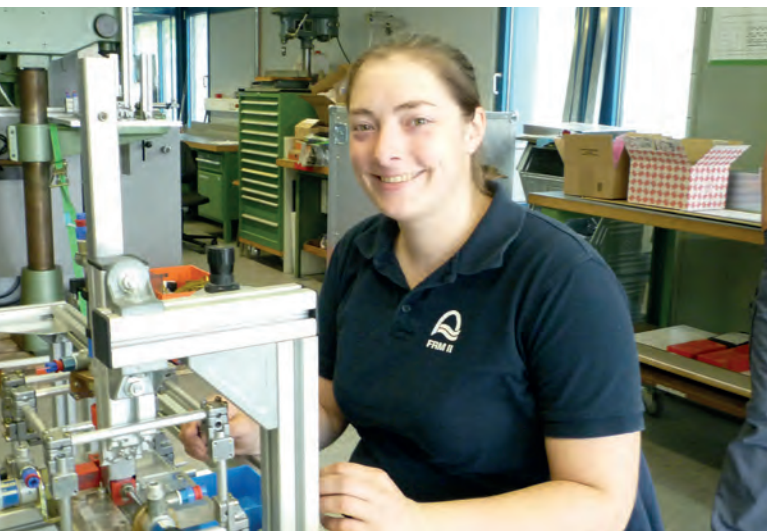

Fig. 1: Apprentice of mechatronics Katharina Bulla obviously likes her job in the TUM-workshop.

### TUM Lab Course

The FRM II as part of the TUM opens unique possibilities for our own students, but also for students from other universities. Undergraduate students of physics can do an advanced lab course on neutron scattering. Twice a year ten different instruments are available for them and

research activities at the neutron source in Garching is significantly reduced during these three days. The TUM professors Petry and Böni offer lectures and seminars on neutrons in research and industry for advanced students, who may also work on their bachelor's or master's thesis at the MLZ. During their study students even may earn some extra money as research assistants. Close connections exist between the Hochschule München (University of applied sciences) and the MLZ. Students from different faculties decide to apply for their obligatory six month internship at the MLZ. So, this cooperation helps to secure at least a good amount of young engineers for the FRM II.

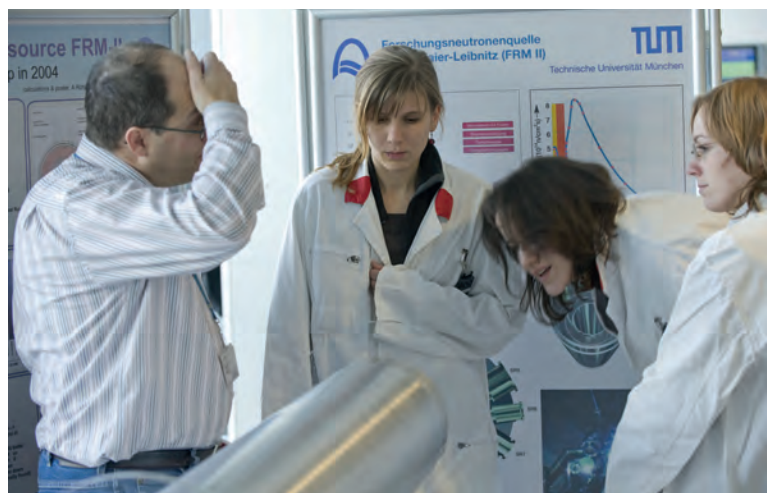

Fig. 2: Participants of a TUM advanced lab course are highly motivated and appreciate the neighbourhood of a neutron source.

### JCNS Lab Course

The Jülich Centre for Neutron Science (JCNS) organises every year, in cooperation with the University of Münster and the RWTH Aachen, a lab course in neutron scattering for graduate students at the MLZ. The aim is to give a realistic insight into the experimental technique of neutron scattering and its scientific potential. It is open to students of physics, chemistry, and other natural sciences from all over the world. The first week is dedicated to a series of lectures, usually in Jülich, and the second week to experiments on neutron scattering at the MLZ. This year the experiments will start on September 9<sup>th</sup> and end September 13<sup>th</sup>. They cover backscattering spectroscopy, polarization analysis, reflectometry, neutron spin-echo, small and ultra-small angle scattering, single crystal diffraction, three axes spectroscopy, powder diffraction and time-of-flight spectroscopy. The lab course is very popular, but unfortunately the experimental places are very limited. The students work in groups of five at twelve different instruments. Last year more than 150 students applied for the course, but only 59 students were selected. They stem from 14 different countries and 22 were female students!

### MaMaSELF

TUM and LMU are partners in a striking Master's program: They offer a **MA**ster in **MA**terials **S**cience **E**xploiting **L**arge-scale **F**acilities (MaMaSELF). It is part of the ERASMUS programme of the EU and the students study at the TUM or the LMU in Munich, the University of Rennes or Montpellier in France or the University of Torino in Italy. These consortium universities bring together different specialisations in a unique course programme. The two year MaMaSELF program is split in four semesters: The first year (SEM 1 & SEM 2) is entirely enrolled at one of the five universities, SEM 3 mandatory at another as the original university. SEM 4 is dedicated to the Master thesis and can be carried out at one of the consortium universities or at one of the participating large scale facilities: ILL Grenoble/France, ESRF Grenoble/France, FRM II Munich/Germany, LLB Saclay/France, DESY Hamburg/Germany, ELETTRA Trieste/Italy and PSI Villigen/Switzerland.

The MaMaSELF Master's Course aims at promoting international collaboration among universities, large scale facilities and industry. Its main objective is to form skilled scientists in material science together with an advanced knowledge in the use of large scale facilities for the characterization of high technology materials. Successful candidates obtain a double or multiple diplomas.



Fig. 3: MaMaSELF students at the TOFTOF instrument.

### University of Paderborn master course

The University of Paderborn offers a very new master course for students of chemistry: They may widen their lectures about the structural elucidation of different material with a small angle neutron scattering experiment at the FRM II. The three day practical work is possible through a cooperation of the Paderborn University with the JCNS at the MLZ. Günter Goerigk took care of the students during theory and practical work and is highly convinced by the concept of this course: *"The course itself was a pioneering teaching experiment, because it*



Fig. 4: The JCNS/MLZ offers a summer school on neutron scattering.

*combines the University of Paderborn theory at home with external experiments in a large scale facility for the first time. Usually we are not able to offer such an opportunity to students without a PhD."*

During the last years the number of neutron facilities was reduced and will be even more in the future, but know how and experts are needed anyhow and highly appreciated. The MLZ assumes a great part of this responsibility and takes care for further training and education in many professions, especially for scientists. This broad range of education is reflected in the large number of PhD projects undertaken at the MLZ. About 50 PhD students are directly linked to the MLZ and even more benefit from the possibility of neutron research as external users of the MLZ.

*C. Kortenbruck (FRM II)*

## Information in a Trice: The MLZ User Office's New Web Pages

On the occasion of the inauguration of the newly established Heinz Maier-Leibnitz Zentrum, the User Office also got new web pages. The access point is

[mlz-garching.de/user-office](http://mlz-garching.de/user-office)

The screenshot shows the MLZ User Office website. The header includes the MLZ logo and the text "Heinz Maier-Leibnitz Zentrum Neutrons for Research, Industry and Medicine". Navigation menus include "About MLZ", "News & Media", "Neutron Research", "Instruments", "Science & Projects", "Industry & Medicine", and "User Office". A secondary menu below includes "Getting beam time", "Your visit at MLZ", "Downloads", and "Manuals".

**Welcome to the User Office!**

The User Office organizes the scientific use of the neutron research source Heinz Maier-Leibnitz (FRM II) at Garching. It also takes care of all needs of the scientists visiting the MLZ in the scope of their scientific work.

Each scientist who plans experiments with neutrons or positrons is invited to submit a proposal online. An international panel reviews the proposals received until the deadline twice a year and recommends the allocation of beam time.

**We look forward to receiving your proposals and welcoming you at the MLZ!**

**Proposal deadlines 2013**

No.	Deadline	Review
17	19.07.2013	05.-06.09.2013
18	to be announced	to be announced

**Reactor cycles 2013**

No.	Start	Stop
31	15.01.2013	15.03.2013
32	09.04.2013	09.06.2013
33	23.07.2013	20.09.2013
34	15.10.2013	13.12.2013

**The User Office Team**

**Dr. Flavio Carsughi**  
Tel.: ++49.(0)89.289.10703

**Dr. Ina Lommatzsch**  
Tel.: ++49.(0)89.289.10794

**Ramona Bucher**  
Tel.: ++49.(0)89.289.11751

[useroffice@mlz-garching.de](mailto:useroffice@mlz-garching.de)

**Downloads**

One page is dedicated to the download of all forms and templates you'll need in the scope of an experiment at the MLZ: proposal and experimental report templates as well as the forms for your dose history and the reimbursement process.

**Manuals**

Finally you can find some manuals for the modules of the User Office System in case you are not that familiar with it. Each module is explained in detail and you can also download a pdf showing how to complete the requested forms like for example „Arrival\_Departure“ where you have to apply for each visit at the MLZ.

**Feedback welcome!**

Do you have any questions, miss anything or want to give some feedback? On each page you find the User Office's contact data on the right. Just write us an email or give us a call. We are really keen to receive your complaints, requests or praise! That is the only way for us to learn how to improve our pages.

On the start page you will always find the dates of the current and the following proposal rounds and in addition the dates of the review panels' meetings. Furthermore you can have a look at the current year's reactor cycle dates. There is also a direct link to the User Office System where proposals are submitted or visits are applied for. The sub-pages cover all relevant topics:

### Getting beam time

The first branch "Getting beam time" shall pave the way for a successful proposal. You are guided how to find information about all available instruments at the MLZ. After that you maybe have to register at the User Office System if not already done. The process is explained in detail, as well as all steps how to write a proposal. Don't miss the insider tips of the User Office! Afterwards you have to wait for the results of the review - you can learn about the process here, too.

### Your visit at the MLZ

"Your visit at MLZ" is divided into three parts, following the sequence of a visit. A visit at the MLZ in the scope of an experiment needs some preparations in advance. The safety regulations as well as the radiation protection regulations must be strictly observed, furthermore you

have to apply for the visit via the User Office online system well in advance. For the next step, you need some information about how to act on site. Where to go first, what to do with the forms you get at the reception – and a little introduction into the Munich public transportation, which is not that easy to understand... And finally you have to do some rework when you are home again. In case your visit was financially supported you have to take care of the reimbursement process, furthermore you are asked to submit your experimental report within the next two months and to follow our publication and acknowledgments policy.

### Downloads

One page is dedicated to the download of all forms and templates you'll need in the scope of an experiment at the MLZ: proposal and experimental report templates as well as the forms for your dose history and the reimbursement process.

### Manuals

Finally you can find some manuals for the modules of the User Office System in case you are not that familiar with it. Each module is explained in detail and you can also download a pdf showing how to complete the requested forms like for example „Arrival\_Departure“ where you have to apply for each visit at the MLZ.

### Feedback welcome!

Do you have any questions, miss anything or want to give some feedback? On each page you find the User Office's contact data on the right. Just write us an email or give us a call. We are really keen to receive your complaints, requests or praise! That is the only way for us to learn how to improve our pages.

### User Office

**Flavio Carsughi**

+49 (0)89 289 10703

**Ina Lommatzsch**

+49 (0)89 289 10794

**Ramona Bucher**

+49 (0)89 289 11751

[useroffice@mlz-garching.de](mailto:useroffice@mlz-garching.de)

## Please do not Forget Proper Acknowledgements in your Publications!

MLZ offers its instruments for non-proprietary investigations free of charge to scientific users. Furthermore, in many cases a financial support to cover travel, accommodation and subsistence costs is also provided.

### Local contacts as co-authors

Our first-class instruments have been developed for many years investing huge human and financial resources, provided by the German federal and local Governments through the institutions present at the MLZ. Each scientist in charge of an instrument has devoted a large fraction of her/his working time to design, build and develop the instrument for the benefit also of the external users, to whom about 2/3 of the available beam time is currently offered. It is therefore important that their work is somehow recognized. At MLZ we expect that the instrument scientist, who assists the external users as local contact during the experiment, is involved as co-author in those publications where the experimental data collected at the MLZ are published.

It should be clear to all users that without the work of the instrument scientist, taking care of the instrument and helping during the measurements, the experiment would not be possible!

### Acknowledgements

Moreover, the users are kindly invited to mention the used instrument(s) and its operating institution in the publication, preferably on the first page of the publication. Alternatively, the following acknowledgement statement shall be used at the end of the publication:

*This work is based upon experiments performed at the [instrument name] instrument operated by [xxx] at the Heinz Maier-Leibnitz Zentrum (MLZ), Garching, Germany.*

(where [xxx] is one (or more) of the following institutions: HZG, JCNS, MPG, FRM II).

## Please Submit your Experimental Reports!

The beam time allocated to you is very valuable, and we expect you to use it at best. Therefore every user, internal as well as external, who performed an experiment at the MLZ is kindly requested to submit an experimental report not later than two months after the end of the experimental session.

The reason for requiring an experimental report is two-fold:

- proving that the investigation performed at the MLZ is non-proprietary research,
- showing that the beam time was successfully used.

Regardless of the status of the analysis of your experimental data, please submit your experimental report on time, and you are welcome to update it anytime you feel like.

### Financial support via the MLZ institutions

Whenever the users received a financial support by one of the institutions operating at the MLZ, they are kindly requested to acknowledge it in any publication by using the following text:

*The authors gratefully acknowledge the financial support provided by [xxx] to perform the neutron scattering measurements at the Heinz Maier-Leibnitz Zentrum (MLZ), Garching, Germany.*

(where [xxx] is one (or more) of the following institutions: HZG, JCNS or FRM II.)

### Financial support via NMI3

In case, users were granted with EU funds through the EU NMI3 project, the following text shall be used:

*This research project has been supported by the European Commission under the 7<sup>th</sup> Framework Programme through the "Research Infrastructures" action of the Capacities Programme, NMI3-II, Grant Agreement number 283883.*

In conclusion, the big effort of the local contact to make her/his scientific and technical expertise as well as her/his services available to the external users for a successful experimental session at the MLZ is remarkable and it should be considered as such. We should all be very grateful to them!

All information can be also found at the MLZ User Office pages

[mlz-garching.de/englisch/user-office/your-visit-at-mlz/home-again](http://mlz-garching.de/englisch/user-office/your-visit-at-mlz/home-again)



Your experimental report will remain unpublished in the MLZ online system up to twelve months after the end of the experiment. After that deadline, it can be searched for after login into the User Office online system.

We take the experimental reports very seriously. Please keep in mind that the lack of an experimental report for one of your experiments may affect the decision on the beam time allocation to any later proposal. In case of submission of a continuation proposal, the lack of the experimental report for the quoted proposal yields automatically to the rejection of the submitted one.

Please do not neglect this task, as it affects the assessment of your new proposals!

## User Satisfaction Survey on Sample Environments Available at the MLZ

At the MLZ, a wide range of sample environment equipment is available for experiments. It includes applications as magnetic fields as well as high pressure and sample temperature control and also specialised equipment for special applications mainly for the SANS instruments. The MLZ sample environment equipment is continuously updated according to the needs of our users, and a detailed overview is available at

[mlz-garching.de/se](http://mlz-garching.de/se)

Instrument	MLZ SE	Own SE	Overall satisfaction	Standard deviation
BIODIFF	3	2	1	0
DNS	2	0	1	0
HEIDI	2	0	1	0
J-NSE	2	0	1,5	0,71
KWS-1	9	2	1,83	0,75
KWS-2	7	1	1,29	0,49
KWS-3	1	0	1,33	-
MIRA	1	0	1	-
NREX	2	0	1,5	0,71
NECTAR	2	1	1,5	0,71
PANDA	12	0	1,18	0,4
PGAA	2	0	1,5	0,71
POLI	1	0	2	-
PUMA	5	0	1,6	0,55
RESI	2	0	1	0
SPHERES	4	0	1	0
SPODI	8	2	1,13	0,35
STRESS-SPEC	4	0	1,67	0,58
TOFTOF	6	0	1,6	0,89
TRISP	5	0	1	0

Overall statistics per instrument. Grades range from 1 (excellent) down to 5 (very poor).

In order to identify fields for improvement not only of the equipment, but also of the support provided to the users, a user satisfaction survey on sample environment was launched in 2012. It was available online from February 17<sup>th</sup>, 2012, through the end of the year, i.e. 318 days. The survey was advertised in many ways, for example via a direct email to those users who performed an experiment at the MLZ during this period.

The survey consisted of two parts, the first one dealing with general questions and the second one with instrument related ones. Grades from 1 (excellent) down to 5

(very poor) could be given and the whole survey was of course anonymous.

For the general questions' part, we received 104 answers. We learned where our users find the information on the available sample environment.

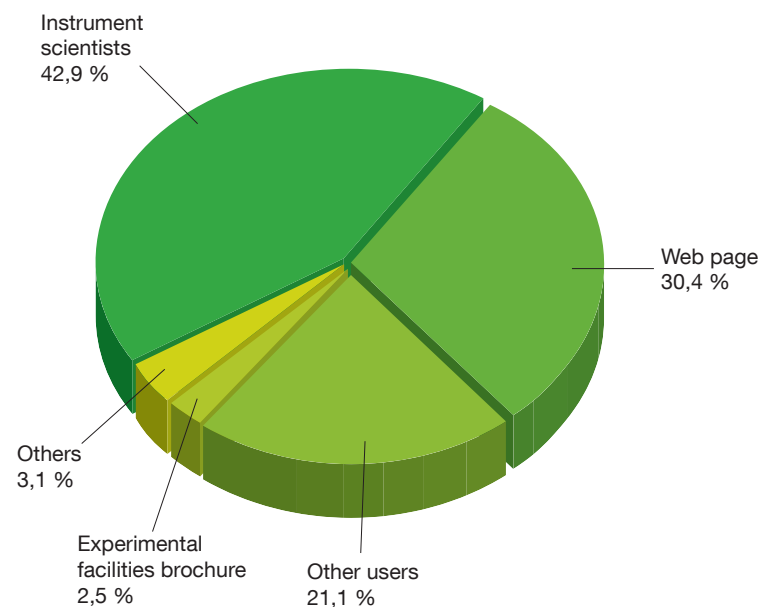

How the users get the information on the sample environments available at the FRM II.

Furthermore we were happy to get a grade for the whole selection of available sample environment of  $1.38 \pm 0.60$ . These sample environments matched most of the participants' needs and they rate it  $1.23 \pm 0.43$ . Some users provided us kindly with a written comment on these two questions: 20 gave their opinion on the first one, 13 on the second one. These comments are more than useful to us as they show the way how we can improve our service to the users. We need your suggestions for new equipment as well as complaints!



A staff member of the sample environment group working at a furnace.

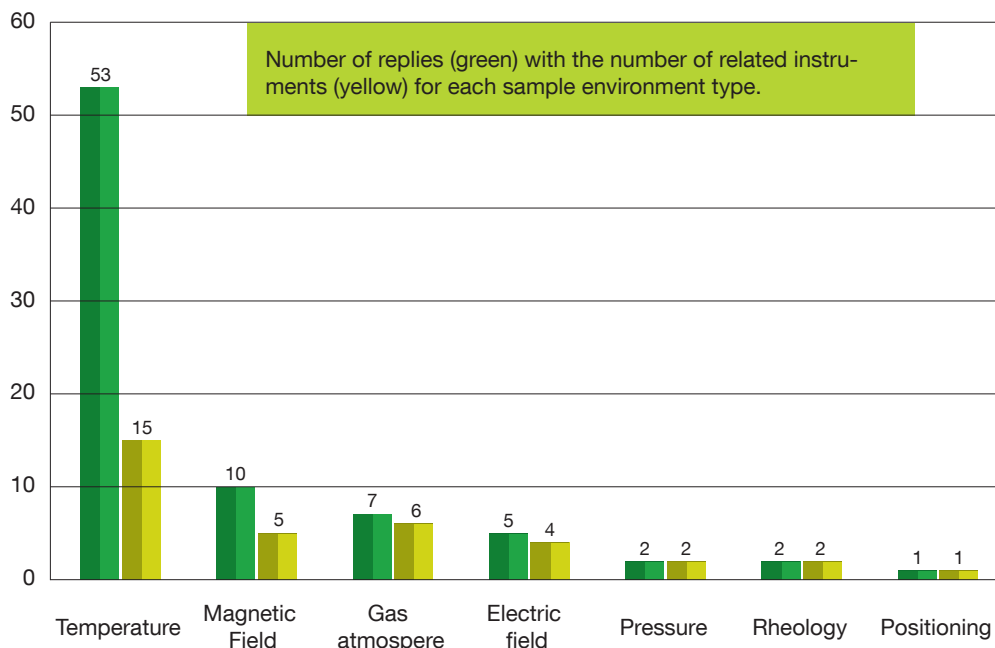

Number of replies (green) with the number of related instruments (yellow) for each sample environment type.

For the instrument related part we received 80 replies.

SPODI in combination with the temperature control got the largest number of replies: 7.

Last but not least, the users informed us about 46 cases of failure of the sample environment in operation during an experiment. In 43 cases they receive immediate support by the MLZ staff.

We would like to thank all users who spent the few minutes to complete our online questionnaire. The whole MLZ user community will benefit from their effort!

## Rapid Access Programme at MLZ Instruments

Sometimes scientists just need a quick material characterisation for tuning its preparation process - but unfortunately for such short term measurements our normal proposal workflow with two deadlines and reviews per year does not fit. Therefore we launch the new Rapid Access Programme.

Within this programme, up to three beam days per reactor cycle, i.e. 60 days, will be allocated to urgent short term measurements. Only the following three instruments are available for this rapid access:

- the high resolution powder diffractometer SPODI,
- the small angle scattering instrument KWS-2, and
- the analytic facility for prompt-gamma-activation analysis PGAA.

Users interested to apply for Rapid Access shall submit a proposal via the User Office system at

- [user.frm2.tum.de](http://user.frm2.tum.de) (for PGAA and SPODI) or
- [fzj.frm2.tum.de](http://fzj.frm2.tum.de) (for KWS-2).

In order to speed up the preparation of a Rapid Access proposal, the scientific case can be described rather short and just need to fit in the abstract section of the online form. Technical details of the proposed experiment can be given on a two pages pdf-file to be uploaded within the online proposal form.

Proposals can be submitted anytime and are reviewed about ten days before the start of each reactor cycle by an internal committee. A detailed discussion of the pro-

posed experiment with the instrument scientist in charge before the submission is mandatory for the acceptance of any Rapid Access proposal. Beam time to Rapid Access proposals is allocated in hours, up to a maximum of twelve hours per proposal. Priority will be given to those proposals with existing samples (at the time of submission) in order to avoid any delay.

For the experiment of a successful Rapid Access proposal the presence of the user is not necessary and therefore the samples shall be sent to the designated local contact that carries out the proposed measurements. The main proposer will be provided with the raw experimental data as well as pre-treated data for further analysis. Any special request shall be agreed in advance with the local contact.

Due to the short duration of the measurements a high degree of standardisation is required and the usage of a complicated sample environment is excluded. It is expected that the measurements will be performed at **Standard Ambient Temperature and Pressure (SATP)** conditions by using a standard sample holder provided by the local contact. However, upon agreement with the local contact, the use of some simple sample environment equipment can be considered.

**The first Rapid Access review process will take place on July 12<sup>th</sup>, 2013.**

## Improving the Review: Two Subcommittees “Magnetism & Spectroscopy”

At the MLZ, like at any large scale facility, the review process ensures a transparent and efficient selection of the submitted proposals. We established the joint review panels in 2012 (we wrote about this in the FRM II News No. 9). In total six panels did their responsible job during the last two review meetings in September 2012 and March 2013.

For both these proposal rounds, we received around 300 proposals. Unfortunately, the distribution of the proposals to the six review panels can not be done evenly because those six areas are differently demanded. Thus, at the last proposal round the members of the review panel “Magnetism & Spectroscopy” had to deal with 102 proposals, which is about 30% of the total number of submitted proposals to one single review panel. This large

number is mainly related to the wide range of scientific applications, which is considered within the review panel.

In order to improve the work of the “Magnetism & Spectroscopy” review panel it was decided to increase the number of members from eleven to 17 and to create two subcommittees, one dealing with inelastic and the other dealing with elastic applications. In this way we do not only reduce the work load on each member of the review panel, but also have additional experts in each field. We have already appointed six new members and we are looking forward to seeing the new structure at work at the next review panel meeting on September 5<sup>th</sup>-6<sup>th</sup>, 2013.

## Important Information regarding the current and the next Proposal Round!

### MBE System: Available for the First Time

For the first time, access to the thin film laboratory for the sample preparation via an MBE system is offered in combination with the reflectometers MARIA and NREX.

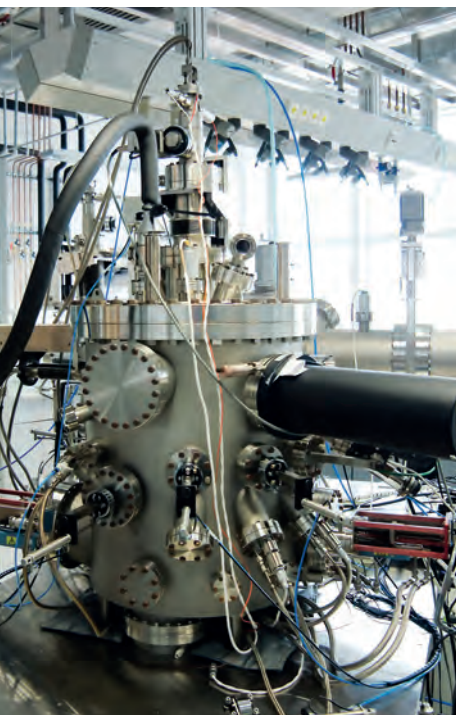

Users can apply for remote access (the sample is fabricated by staff scientists without the user), or collaborative access (the user fabricates the sample under the supervision of staff scientists).

In order to apply for such an access to the thin film laboratory, you have to complete an additional form. Within this, the sample you would like to prepare has to be described in detail. Please find further information at

[mlz-garching.de/englisch/instruments/user-labs/thin-film-lab](http://mlz-garching.de/englisch/instruments/user-labs/thin-film-lab)

### Long Maintenance Break in 2014: No Proposal Round in January 2014

Please note that there will be a long maintenance break in 2014. Starting in the end of January/ beginning of February 2014, the FRM II will be shut down for six months until around August 2014.

Ten years after the FRM II started operation, several recurring tests have to be carried out.

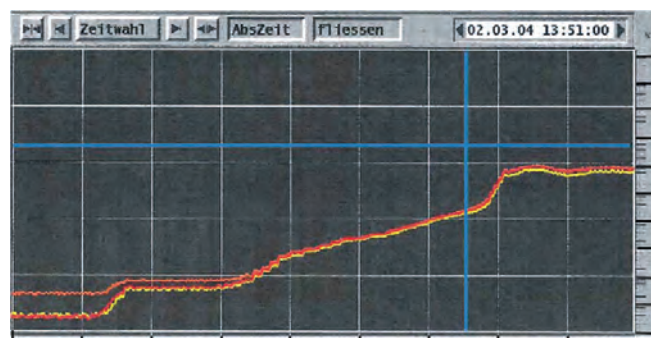

March 2<sup>nd</sup>, 2004: The FRM II went critically for the first time.

120 days of beam time are planned - only the half of the usual 240 days per year. Therefore, the first proposal round in January 2014 will be skipped and there will only be the second one in July. The MLZ User Office will update the user community permanently. We will publish the definite date of the deadline on our web page and remind all registered users via email.



## Call for Proposals: Next Deadline July 19<sup>th</sup>, 2013

Instrument	Description	Neutrons
<b>Diffraction</b>		
BIODIFF	Diffractometer for large unit cells	cold
HEIDI	Single crystal diffractometer	hot
MIRA	Multipurpose instrument	cold
POLI	Polarized neutron diffractometer	hot
RESI	Single crystal diffractometer	thermal
SPODI	High resolution powder diffractometer	thermal
STRESS-SPEC	Materials science diffractometer	thermal
<b>SANS and Reflectometry</b>		
KWS-1	Small angle scattering	cold
KWS-2	Small angle scattering	cold
KWS-3	Very small angle scattering	cold
MARIA	Magnetic reflectometer	cold
NREX	Reflectometer with X-ray option	cold
REFSANS	Time-of-flight reflectometer	cold
SANS-1	Small angle scattering	cold
<b>Spectroscopy</b>		
DNS	Diffuse scattering spectrometer	cold
J-NSE	Spin-echo spectrometer	cold
PANDA	Three axes spectrometer	cold
PUMA	Three axes spectrometer	thermal
RESEDA	Resonance spin-echo spectrometer	cold
SPHERES	Backscattering spectrometer	cold
TOFTOF	Time-of-flight spectrometer	cold
TRISP	Three axes spin-echo spectrometer	thermal
<b>Imaging</b>		
ANTARES	Radiography and tomography	cold
NECTAR	Radiography and tomography	fast
PGAA	Prompt gamma activation analysis	cold
<b>Positrons</b>		
NEPOMUC	Positron source, CDBS, PAES, PLEPS, SPM	-

Just **register** at the User Office online system. There you can access the proposal and reporting system. For additional information please have a look at [mlz-garching.de/user-office](http://mlz-garching.de/user-office)

Proposals have to be **submitted** via the web portals within your personal account

○ for FRM II, HZG, MPG instruments

[user.frm2.tum.de](http://user.frm2.tum.de)

○ for JCNS instruments

[fzj.frm2.tum.de](http://fzj.frm2.tum.de)

The next **review** will take place on September 5<sup>th</sup>-6<sup>th</sup>, 2013. Results of that review panels' meeting will be online about two weeks later.

### Financial Support

The FRM II is a partner in the EU supported network of European neutron facilities (NMI3-II in FP7). **Researchers working in EU Member States or Associated States** other than Germany can apply for travel and subsistence reimbursement.

**Researchers working at German universities** can apply for travel and subsistence reimbursement granted by the FRM II, JCNS, and HZG .

[mlz-garching.de/englisch/user-office/your-visit-at-mlz/home-again](http://mlz-garching.de/englisch/user-office/your-visit-at-mlz/home-again)

To ensure the **feasibility** of the proposed experiment please contact the instrument scientist in advance.

**In addition** to beam tube experiments, irradiation facilities are available for neutron activation analysis, isotope production and silicon doping.

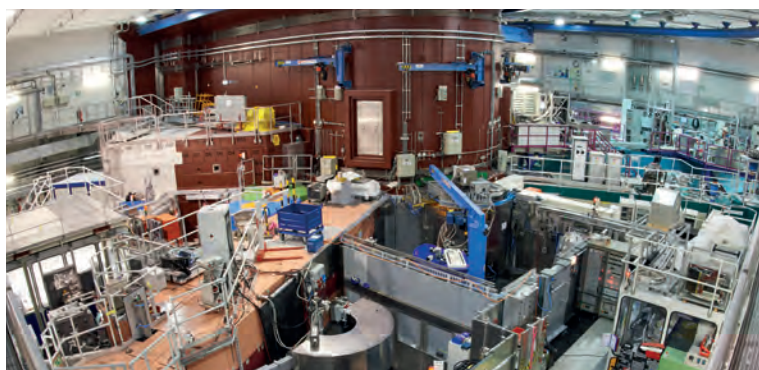

## Upcoming

### July 08-12, 2013

International Conference on Neutron Scattering  
(Edinburgh, United Kingdom)

[www.icns2013.org](http://www.icns2013.org)

*Visit our booth there!*

### September 02-13, 2013

17<sup>th</sup> JCNS Laboratory Course - Neutron Scattering  
(Jülich/ Garching, Germany)

[www.neutronlab.de](http://www.neutronlab.de)

### September 09-12, 2013

NINMACH 2013 - 1<sup>st</sup> International Conference on Neutron Imaging and Neutron Methods in Archaeology and Cultural Heritage Research  
(Garching, Germany)

[www.frm2.tum.de/NINMACH2013](http://www.frm2.tum.de/NINMACH2013)

### September 15-20, 2013

13<sup>th</sup> International Workshop on Slow Positron Beam Techniques and Applications  
(Garching, Germany)

[www.slopos13.com](http://www.slopos13.com)

### October 07-10, 2013

JCNS Workshop 2013: Trends and Perspectives in Neutron Scattering: Magnetism and Correlated Electron Systems  
(Tutzing, Germany)

[www.fz-juelich.de/jcns/JCNS-Workshop2013](http://www.fz-juelich.de/jcns/JCNS-Workshop2013)

### October 10-11, 2013

Single Crystal Spectroscopy: Multi-TAS or TOF?  
(Murnau, Germany)

[www.fz-juelich.de/jcns/TAS-Workshop2013](http://www.fz-juelich.de/jcns/TAS-Workshop2013)

### October 19, 2013

Open Day at the neutron source FRM II and the campus Garching  
(Garching, Germany)

[www.frm2.tum.de](http://www.frm2.tum.de)

## Imprint

### Editors

Rainer Bruchhaus  
Flavio Carsughi  
Connie Hesse  
Christine Kortenbruck  
Ina Lommatzsch  
Jürgen Neuhaus  
Andrea Voit

### Layout and Typesetting

Ramona Bucher  
Ina Lommatzsch

### Picture Credits

A. Eckert/ A. Heddergott, TUM (2 above, 7 right, 26 below), Forschungszentrum Jülich (2 below), D. Holland-Moritz, DLR (27 above), A. Kastenmüller, FRM II (40 left), D. Korolkov (40 left), Fotostudio Naglik, Erding (31 above right), W. Schürmann, TUM (14, 34 above, 35, 38, 41).

If not indicated: By editors, authors and/ or FRM II.

### Contact

Forschungs-Neutronenquelle  
Heinz Maier-Leibnitz (FRM II)  
User Office

Lichtenbergstraße 1  
D-85747 Garching

Phone: +49.(0)89.289.10794  
10703  
11751

Fax: +49.(0)89.289.10799

e-mail: [useroffice@mlz-garching.de](mailto:useroffice@mlz-garching.de)

[www.mlz-garching.de](http://www.mlz-garching.de)



R. Bucher (FRM II)

**How can it be  
Believe me  
The sun always shines on ...  
the FRM II!**

SPONSORED BY THE



Federal Ministry  
of Education  
and Research

Bayerisches Staatsministerium für  
Wissenschaft, Forschung und Kunst

